



Bulletin HY14-2536-M5/US
Service Bulletin

Series D1VW, F Style 91 Design

Effective: May 1, 2007

Directional Control Valves

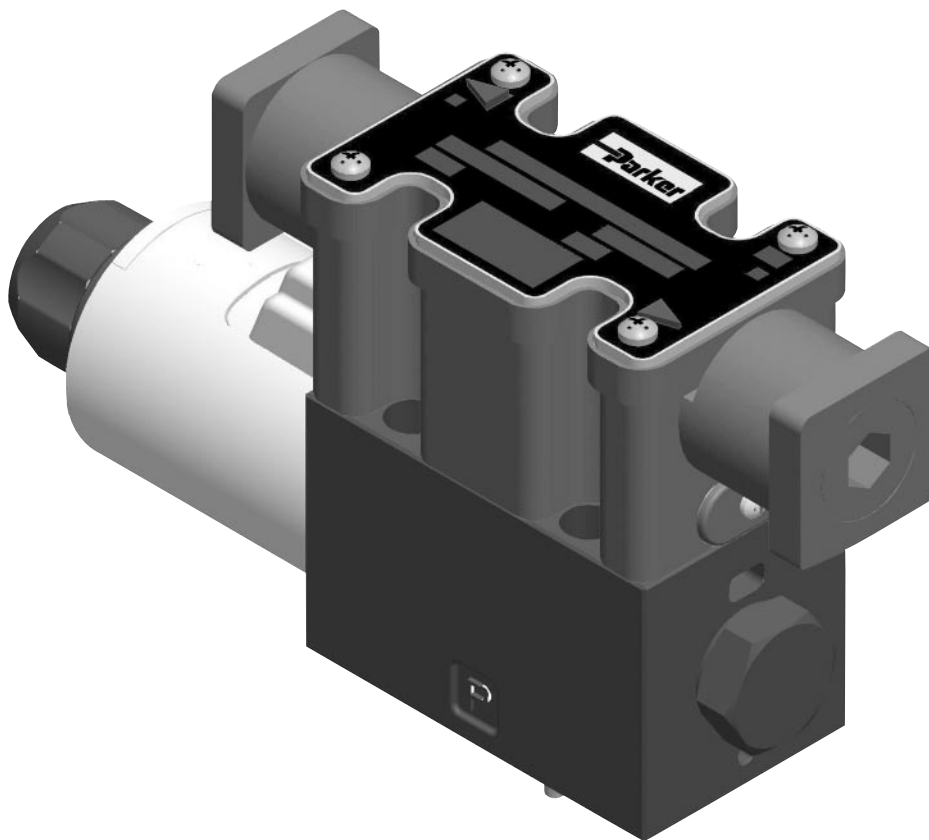



WARNING – USER RESPONSIBILITY

FAILURE OR IMPROPER SELECTION OR IMPROPER USE OF THE PRODUCTS DESCRIBED HEREIN OR RELATED ITEMS CAN CAUSE DEATH, PERSONAL INJURY AND PROPERTY DAMAGE.

- This document and other information from Parker-Hannifin Corporation, its subsidiaries and authorized distributors provide product or system options for further investigation by users having technical expertise.
- The user, through its own analysis and testing, is solely responsible for making the final selection of the system and components and assuring that all performance, endurance, maintenance, safety and warning requirements of the application are met. The user must analyze all aspects of the application, follow applicable industry standards, and follow the information concerning the product in the current product catalog and in any other materials provided from Parker or its subsidiaries or authorized distributors.
- To the extent that Parker or its subsidiaries or authorized distributors provide component or system options based upon data or specifications provided by the user, the user is responsible for determining that such data and specifications are suitable and sufficient for all applications and reasonably foreseeable uses of the components or systems.

OFFER OF SALE

The items described in this document are hereby offered for sale by Parker-Hannifin Corporation, its subsidiaries or its authorized distributors. This offer and its acceptance are governed by the provisions stated in the detailed "Offer of Sale" elsewhere in this document or available at www.parker.com/hydraulicvalve.

SAFETY GUIDE

For safety information, see Safety Guide SG HY14-1000 at www.parker.com/safety or call 1-800-CParker.

© Copyright 2007, Parker Hannifin Corporation, All Rights Reserved

Bul HY14-2536-M5.indd, dd



Model Code

Standard Valves.....	1-2
----------------------	-----

Parts Data

D1VW***F**G5*-91 (Conduit Box, Plug-In)	3
---	---

D1VW***F**C*-91* (Conduit Box, Leadwire).....	4
---	---

D1VW***F**P*-91, D1VW***F**W*-91, D1VW***F**S*-91, D1VW***F**M*-91 (DIN, Spade, Metri-Pak)	5
--	---

D1VW***F**GS*5*-91 (Conduit Box, Soft Shift, Plug-In).....	6
--	---

D1VW***F**PGS*-91 (DIN Soft Shift)	7
--	---

D1VW***F**EU-91, D1VW***F**ED-91, D1VW***F**EE*-91, D1VW***F**EO*-91 (Explosion Proof)	8
--	---

Ordering Information	9-11
-----------------------------------	------

Spool Chart	12
--------------------------	----

Wiring Instructions	13-14
----------------------------------	-------

Coil Data	15
------------------------	----

Troubleshooting Guide	16-17
------------------------------------	-------

Terms of Sale with Warranty Limitations	18
--	----

Standard Valves

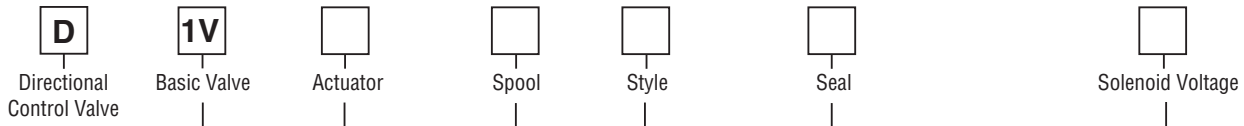

NFPA D03
CETOP 3
DIN NG6

Code	Description
W*	Solenoid, Wet Pin, Screw-in
HW*	Reversed Wiring

Code	Description
N	Nitrile
V	Fluorocarbon
E*	EPR

Code	Description
A**	24/50 VAC
D	120 VDC
G	198 VDC
J	24 VDC
K	12 VDC
L	6 VDC
N***	220/50 VAC
P***	110/50 VAC
Q**	100/60 VAC
QD	100/60 - 100/50 VAC
R	24/60 VAC
T	240/60 - 220/50 VAC
U	98 VDC
Y	120/60 - 110/50 VAC
Z	250 VDC

* Valve schematic symbols are per NFPA/ANSI standards, providing flow P to A when energizing solenoid A. Note operators reverse sides for #008 and #009 spools. See installation information for details. To configure per DIN standards (A coil over A port, B coil over B port) code valves as D1VHW***.

* Contact HVD for availability.

** High Watt only
*** Explosion Proof only.

Code	Symbol	Code	Symbol
001		011	
002		014	
003		015	
004		016	
005		020*	
006		026*	
007		030**	
008*, 009**		081	
010		082	

* 008, 020 & 026 spools have closed crossover.
** 009 & 030 spool have open crossover.
See Universal Spool Chart for other spool options.

Code	Description	Symbol
B*	Single solenoid, 2 position, spring offset. P to A and B to T in offset position.	
C	Double solenoid, 3 position, spring centered.	
D†	Double solenoid, 2 position, detent.	
E	Single solenoid, 2 position, spring centered. P to B and A to T when energized.	
F‡	Single solenoid, 2 position. Spring offset, energized to center. Position spool spacer on A side. P to A and B to T in spring offset position.	
H*	Single solenoid, 2 position, spring offset. P to B and A to T in offset position.	
K	Single solenoid, 2 position, spring centered. P to A and B to T when energized.	
M‡	Single solenoid, 2 position, spring offset, energized to center position. Spool spacer on B side. P to B and A to T in spring offset position.	

* 020, 026 and 030 spools only.
† 020 and 030 spools only.
‡ High Watt only.

Bold: Designates Tier I products and options.

**Non-Bold: Designates Tier II products and options.
These products will have longer lead times.**

Standard Valves

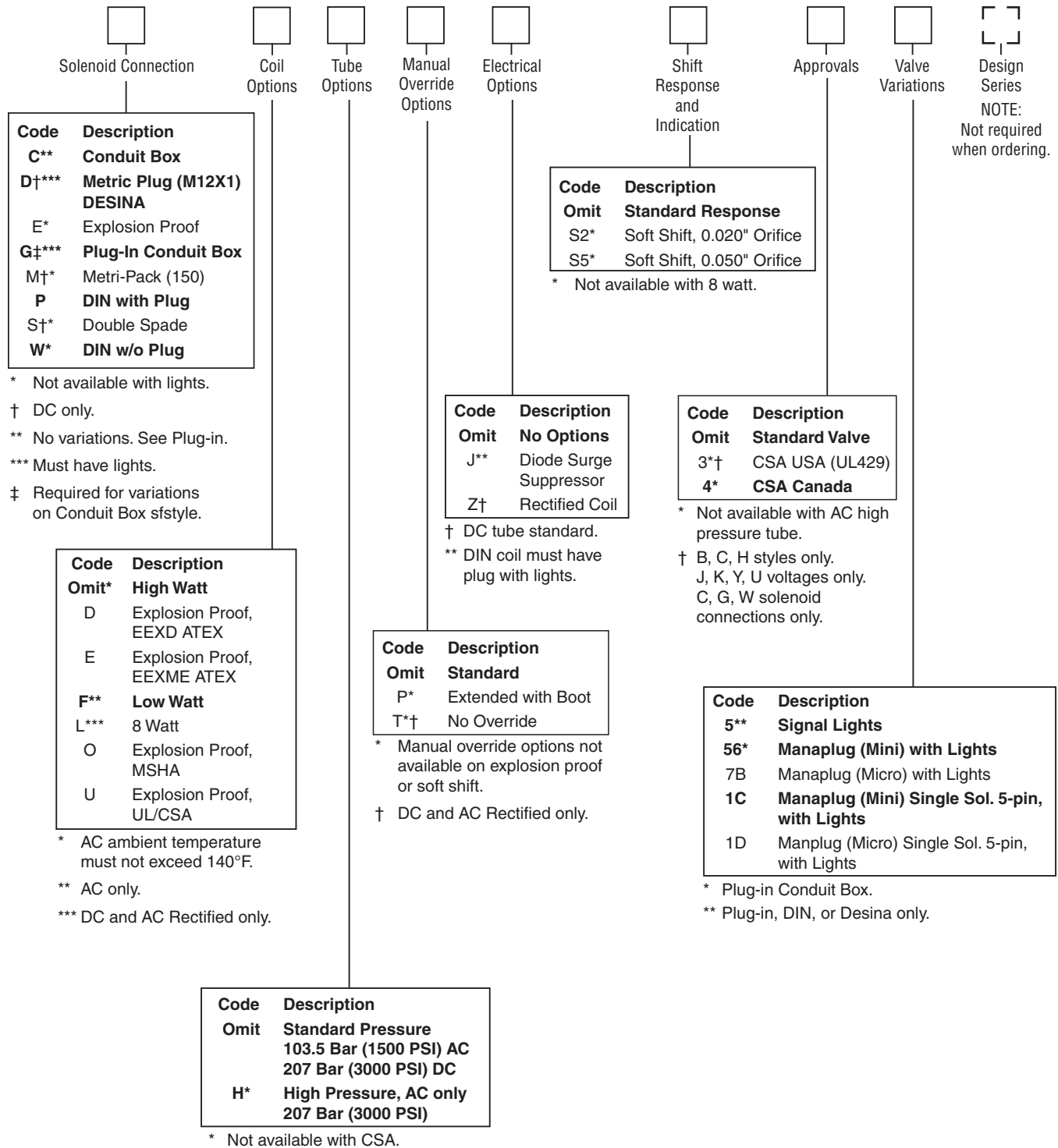

Bold: Designates Tier I products and options.

**Non-Bold: Designates Tier II products and options.
These products will have longer lead times.**

D1VW*F**G5*-91 Conduit Box, Plug-in**

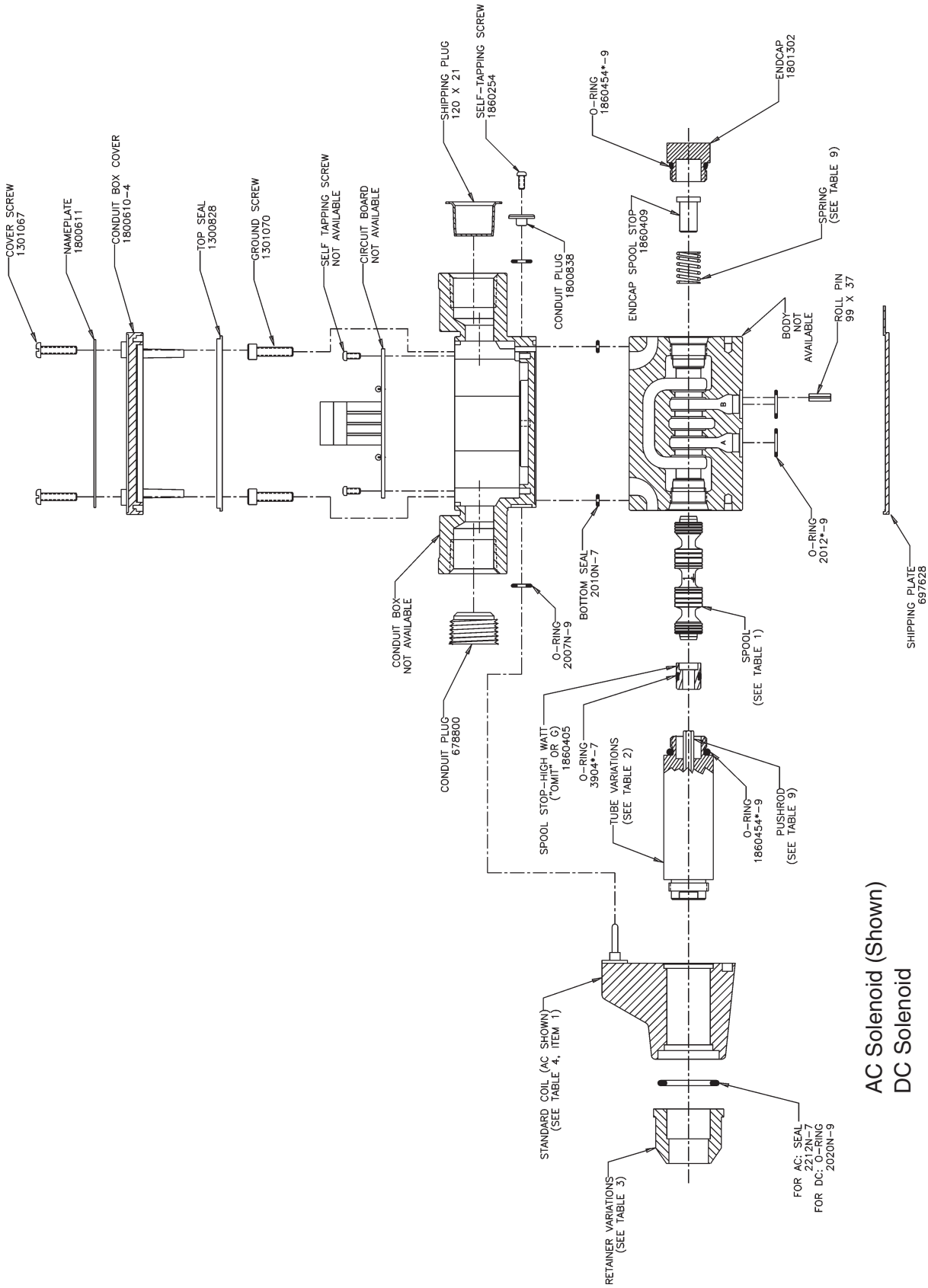

AC Solenoid (Shown)
DC Solenoid

D1VW Single A.C. Solenoid Model
D1VW Single D.C. Solenoid Model

- Notes:
- 1) * Indicates Seal Compound:
 N = Nitrile, V = Fluorocarbon, E = EPR



D1VW*F**C*-91 Conduit Box, Leadwire**

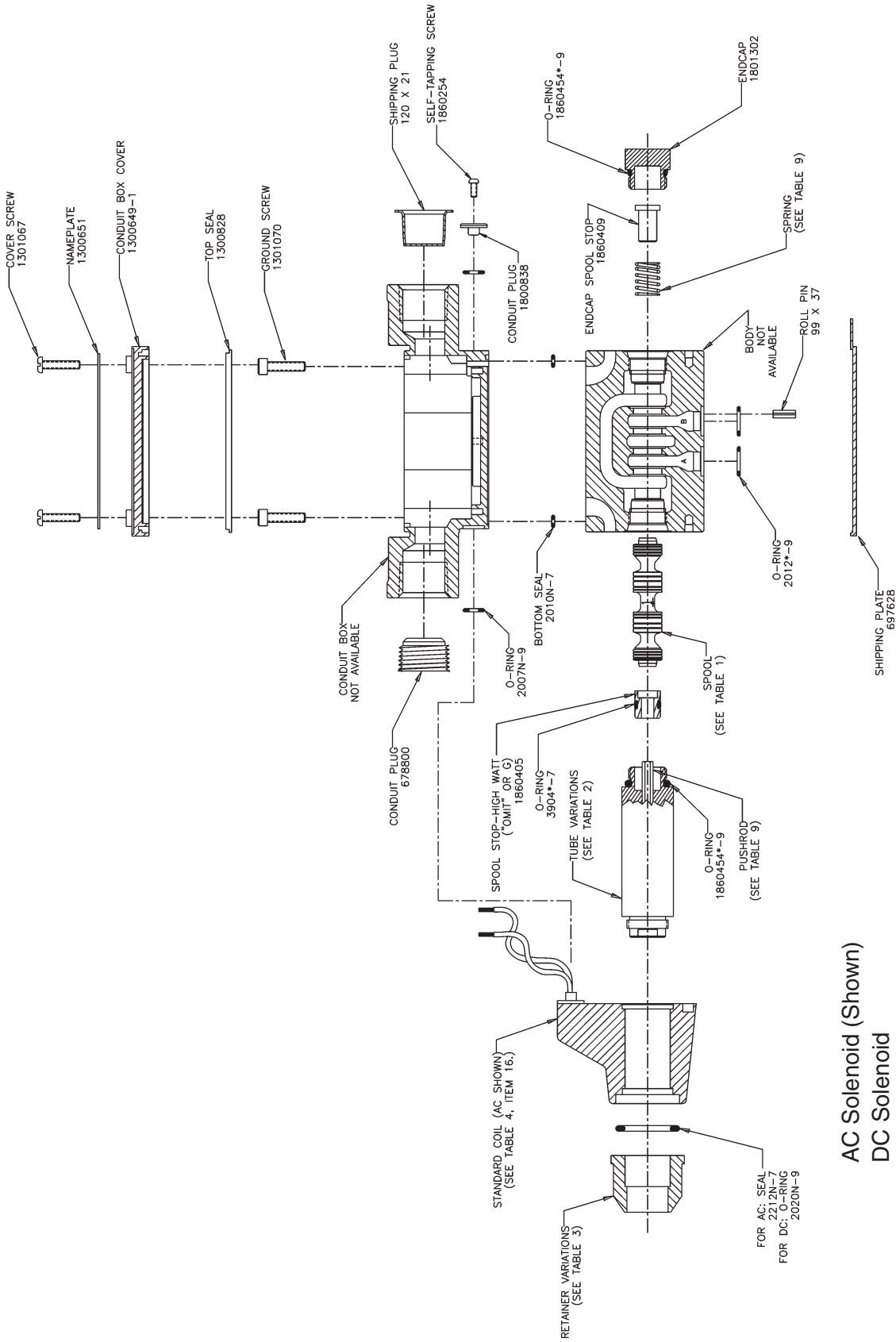

AC Solenoid (Shown)
DC Solenoid

D1VW Single A.C. Solenoid Model
D1VW Single D.C. Solenoid Model

Notes:
 1) * Indicates Seal Compound:
 N = Nitrile, V = Fluorocarbon, E = EPR



D1VW*F**P*-91**
D1VW*F**W*-91**

DIN with Plug
DIN without Plug

D1VW*F**S*-91**
D1VW*F**M*-91**

Dual Spade
Metri-Pack

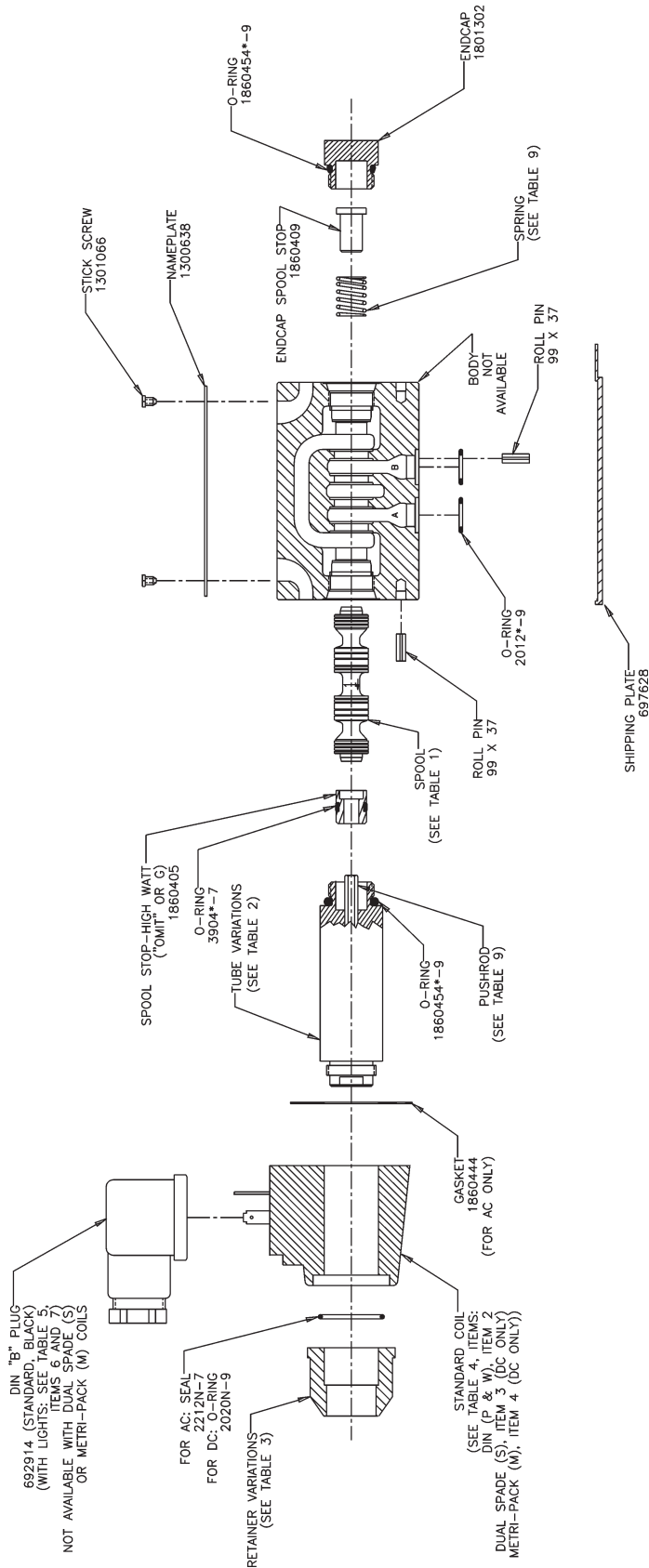

AC Solenoid (Shown)
 (Not available with 8 watt option)
DC Solenoid

D1VW Single A.C. Solenoid Model
D1VW Single D.C. Solenoid Model

Note:
 1) * Indicates Seal Compound:
 N = Nitrile, V = Fluorocarbon, E = EPR

D1VW*F**GG5*5*-91 Conduit Box Soft Shift, Plug-in**

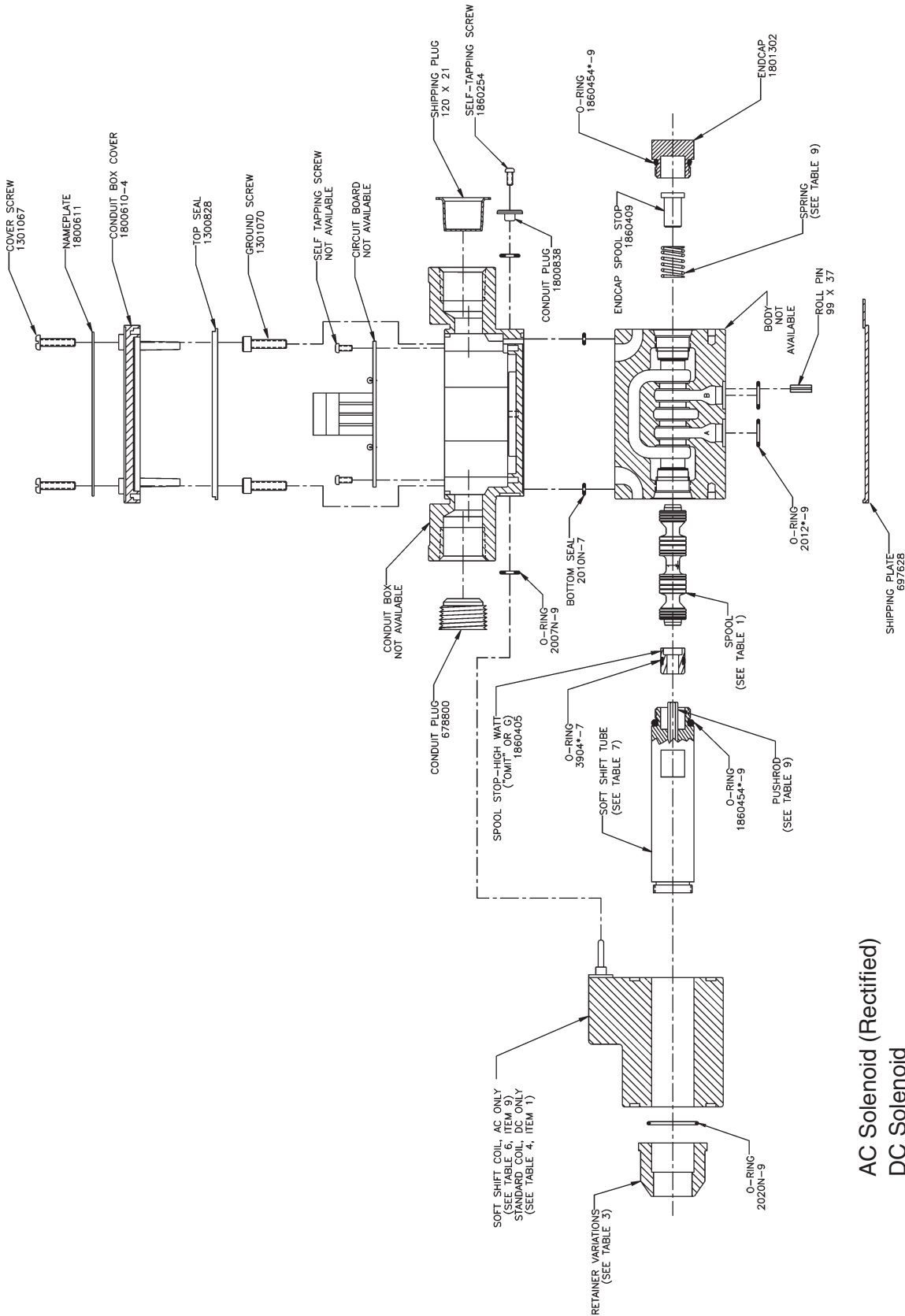

D1VW Single A.C. Solenoid Model
 D1VW Single D.C. Solenoid Model

AC Solenoid (Rectified)
DC Solenoid

Notes:
 1) * Indicates Seal Compound:
 N = Nitrile, V = Fluorocarbon, E = EPR



D1VW*F**PGS*-91 DIN Soft Shift with Plug (Required with AC)**
D1VW*F**WGS*-91 DIN Soft Shift without Plug (DC Only)**

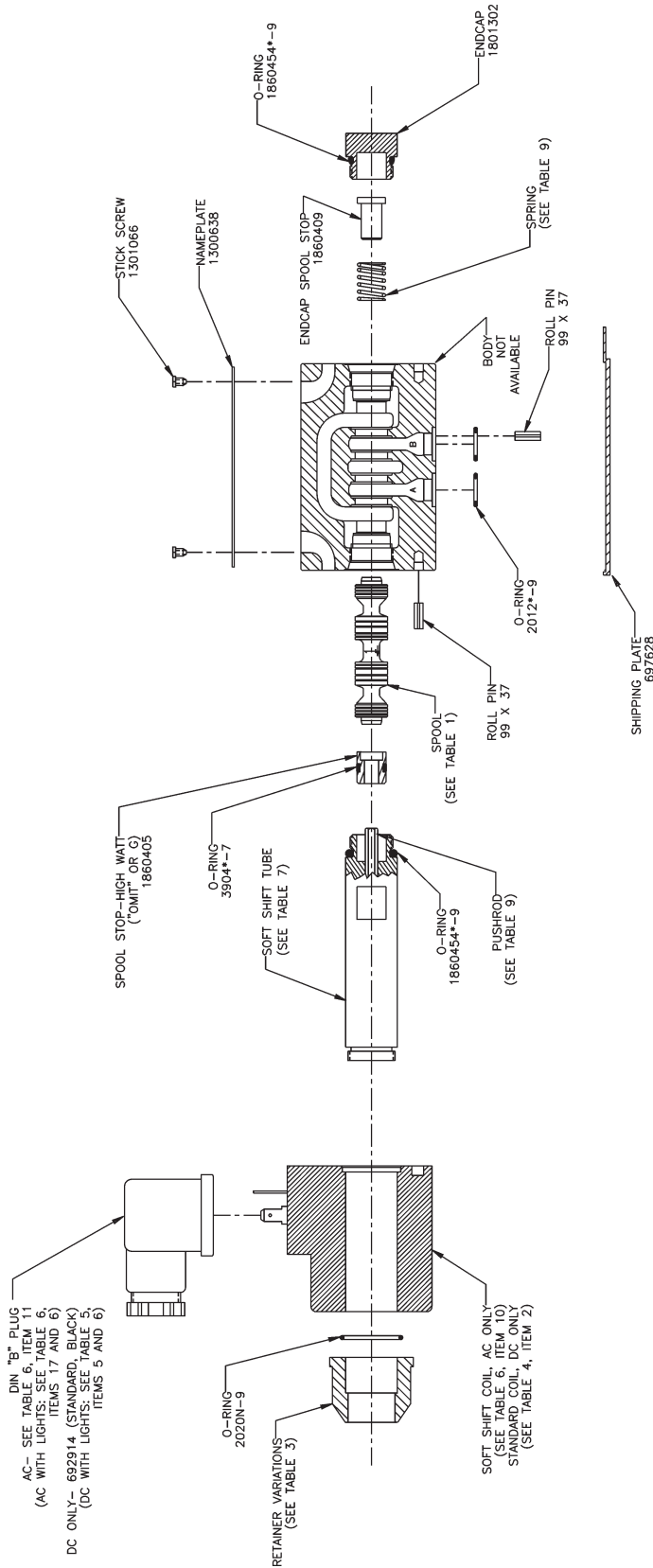

AC Solenoid
DC Solenoid

D1VW Single A.C. Solenoid Model
D1VW Single D.C. Solenoid Model

Note:
 1) * Indicates Seal Compound:
 N = Nitrile, V = Fluorocarbon, E = EPR

D1VW*F**EU-91**
D1VW*F**ED-91**

UL / CSA
ATEX EEXD

D1VW*F**EE*-91**
D1VW*F**EO*-91**

ATEX EEXME
MSHA

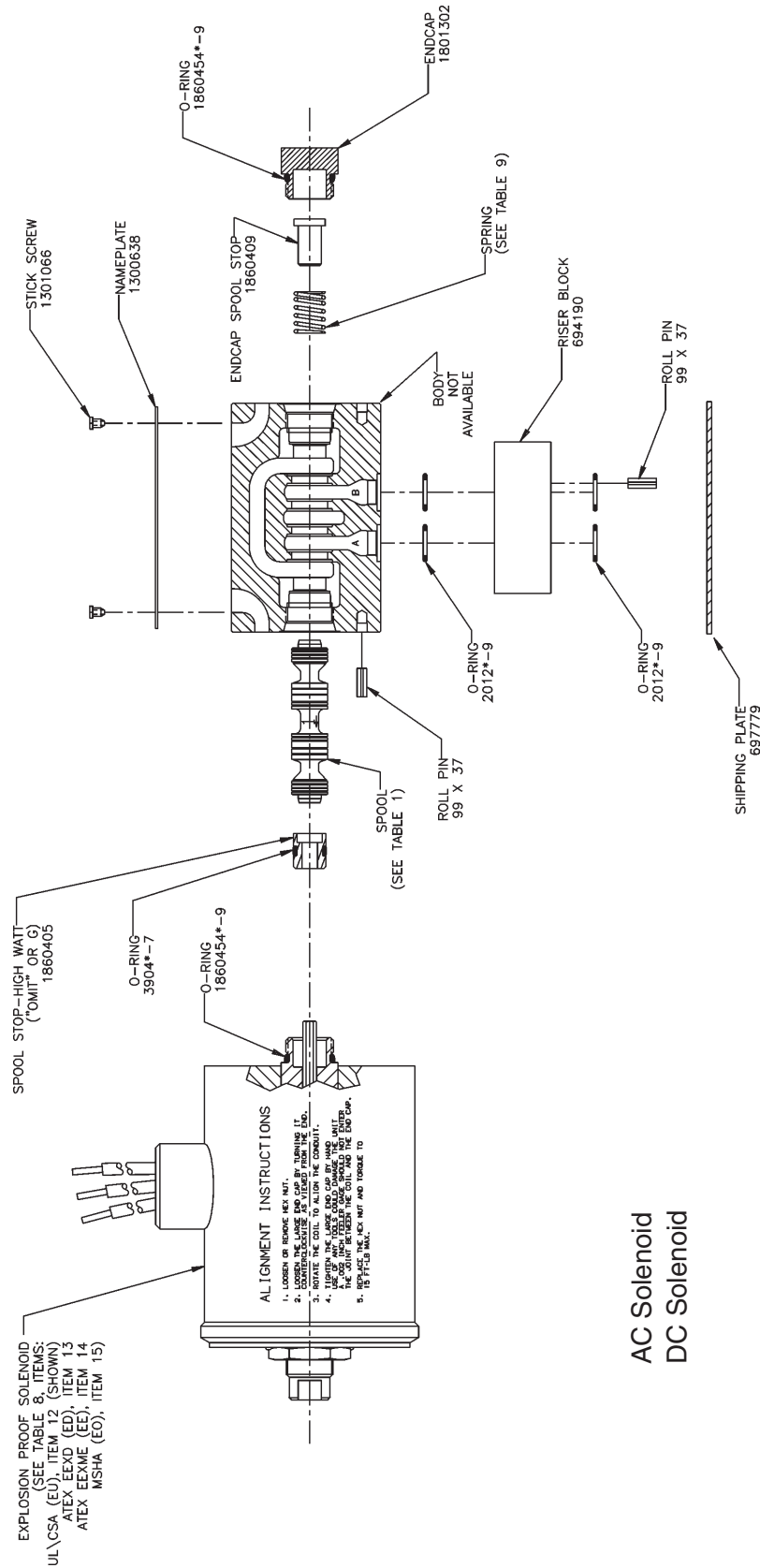

D1VW Single A.C. Solenoid Explosion Proof Model
D1VW Single D.C. Solenoid Explosion Proof Model

Note:
 1) * Indicates Seal Compound:
 N = Nitrile, V = Fluorocarbon, E = EPR

Code	Part Number	Qty	Description
1	697601	1	#1 Spool
2	697602	1	#2 Spool
3	697603	1	#3 Spool
4	697604	1	#4 Spool
5	697605	1	#5 Spool
6	697606	1	#6 Spool
7	697607	1	#7 Spool
8	697608	1	#8 Spool
9	1302128	1	#9 Spool
10	697610	1	#10 Spool
11	697611	1	#11 Spool
14	697607	1	#7 Spool Reversed
15	697603	1	#3 Spool Reversed
16	697605	1	#5 Spool Reversed
21	697621	1	#21 Spool
22	697621	1	#21 Spool Reversed
81	1210011	1	#1 20% Overlap Spool
82	1210012	1	#11 20% Bleed Spool

△1

△1 Arrow points toward "A" port for all spools except: 14, 15, 16 & 22.

△2 81 and 82 spools not applicable with explosion proof options.

Code	Part Number	Qty	Description
Omit or F	1860432	1	A.C. Tube 1500 PSI
H	1860431	1	A.C. Tube 3000 PSI
G	1860428		D.C. Tube 3000 PSI
P or FP	1860434	1	Extended A.C. Tube 1500 PSI
HP or FHP	1860433	1	Extended A.C. Tube 3000 PSI
GP or LGP	1860429		Extended D.C. Tube 3000 PSI

Code	Part Number	Qty	Description
All Except P & T	1860456	1	AC Standard Retainer
	1860437		DC Standard Retainer
P or FP HP or FHP	1860463	1	AC Extended Override Retainer
	1860452		AC Extended Override Boot
P GP or LGP	1860437	1	DC Extended Override Retainer
	1860452		DC Extended Override Boot
T	1860438	1	DC Tamper Proof Retainer

Solenoid Connection			G (Conduit Box) (Plug-In)	P & W (DIN)	S (Dual Spade)	M (Metri-Pack)	C (Conduit Box) (Leadwire)
Code	Description	Qty	Part Number	Part Number	Part Number	Part Number	Part Number
Y*	120/60–110/50 VAC 21 Watt	1	1860422-21-Y	1860423-21-Y	N/A	N/A	1860436-21-Y
T*	240/60–220/50 VAC 21 Watt	1	1860422-21-T	1860423-21-T	N/A	N/A	1860436-21-T
QD	100/60–100/50 VAC	1	N/A	1860423-25-QD	N/A	N/A	N/A
R*	24/60 21 Watt	1	1860422-21-R	N/A	N/A	N/A	1860436-21-R
L*	6 VDC	1	1860410-30-6	1860414-30-6	1860415-30-6	1860413-30-6	1860435-30-6
K*	12 VDC	1	1860410-30-12	1860414-30-12	1860415-30-12	1860413-30-12	1860435-30-12
KL	12 VDC 8 Watt	1	1860410-10-12	1860414-10-12	1860415-10-12	1860413-10-12	1860435-10-12
J*	24 VDC	1	1860410-30-24	1860414-30-24	1860415-30-24	1860413-30-24	1860435-30-24
JL	24 VDC 8 Watt	1	1860410-10-24	1860414-10-24	1860415-10-24	1860413-10-24	1860435-10-24
D*	120 VDC	1	1860410-30-120	1860414-30-120	1860415-30-120	1860413-30-120	1860435-30-120
DL	120 VDC 8 Watt	1	1860410-10-120	1860414-10-120	1860415-10-120	1860413-10-120	1860435-10-120
Z*	250 VDC	1	1860410-30-250	1860414-30-250	1860415-30-250	1860413-30-250	1860435-30-250
ZL	250 VDC 8 Watt	1	1860410-10-250	1860414-10-250	1860415-10-250	1860413-10-250	1860435-10-250
U*	98 VDC	1	N/A	1860414-30-98	N/A	1860413-30-98	N/A
G*	198 VDC	1	N/A	1860414-30-198	N/A	1860413-30-198	N/A

Code	Item	Part Number	Qty	Description
ALL	6	697048	1	Label – "B" Solenoid
YP*5	7	694936	1	Plug with Light, 100-120V
QP*5		694936	1	Plug with Light, 100-120V
QDP*5		694936	1	Plug with Light, 100-120V
TP*5		694936	1	Plug with Light, 240V
KP*5		694935	1	Plug with Light, 12V
JP*5		694935	1	Plug with Light, 24V
DP*5		694936	1	Plug with Light, 100-120V

Code	Part Number	Qty	Description
GS2	1860430-2	1	3000 PSI Soft Shift Tube, .020" Orifice
GS3	1860430-3	1	3000 PSI Soft Shift Tube, .030" Orifice
GS4	1860430-4	1	3000 PSI Soft Shift Tube, .040" Orifice
GS5	1860430-5	1	3000 PSI Soft Shift Tube, .050" Orifice

Solenoid Connection			C (Conduit)	P (DIN w/Plug)	DIN Plugs, AC Rectified Only**			
Item			9	10				
Code	Description	Qty	Part Number	Part Number	Item	Description	Qty	Part Number
Y*G	120/60–110/50 VAC	1	1860410-30-98	1860414-30-98	11	Rectified Standard, Plug "A"	1	1301053
T*G	240/60–220/50 VAC	1	1860410-30-214	1860414-30-214	17 5	Rectified with Lights, Plug "A"	1	1300712
QD*G	100/60–100/50 VAC	1	1860410-30-86	1860414-30-86		Label, "A" Solenoid	1	697047

**Must be rectified plug when using AC with soft shift.

Solenoid Connection			U (UL/CSA)	D (EEXD)	E (EEXME)	O (MSHA)
Item			12	13	14	15
Code	Description	Qty	Part Number	Part Number	Part Number	Part Number
YE	120/60–110/50 VAC	1	1860427-27-Y	1860424-25-Y	1860425-30-Y	1860426-27-Y
TE	240/60–220/50 VAC	1	1860427-27-T	1860424-25-T	1860425-30-T	1860426-27-T
QE	100/60 VAC	1	1860427-27-Q	1860424-25-Q	1860425-30-Q	1860426-27-Q
RE	24/60 VAC	1	1860427-27-R	N/A	1860425-30-R	1860426-27-R
AE	24/50 VAC	1	N/A	1860424-17-A	1860425-30-A	N/A
NE	220/50 VAC	1	1860427-27-N	1860424-25-N	1860425-30-N	N/A
PE	110/50 VAC	1	1860427-27-P	1860424-25-P	1860425-30-P	N/A
LE	6 VDC	1	1860421-33-6	1860418-33-6	1860419-30-6	1860420-33-6
KE	12 VDC	1	1860421-33-12	1860418-33-12	1860419-30-12	1860420-33-12
JE	24 VDC	1	1860421-33-24	1860418-33-24	1860419-30-24	1860420-33-24
DE	120 VDC	1	1860421-33-120	1860418-33-120	1860419-30-120	1860420-33-120
ZE	250 VDC	1	1860421-33-250	1860418-33-250	1860419-30-250	1860420-33-250

Table 9 – D1VW-91 Springs and Pushrods

Valve	Spool	Description	Style	Spring			Pushrod							
				1860447	1860446	1860445	1860400	1860401	1860402	1860403	1860404	1860439	1860441	
Standard (Non-Soft Shift) Valve	1, 4, 10, 11, 21, 22	DC-8W	All Except F/M											
		DC-30W	All Except F/M											
		AC-21W	All Except F/M											
		AC-30W	All Except F/M											
		DC-8W	F & M											
		DC-30W	F & M											
		AC-21W	F & M											
		AC-30W	F & M											
	2, 3/15, 5/16, 6, 7, 8, 9, 14, 16, 20, 30	DC-8W	All Except F/M											
		DC-30W	All Except F/M											
		AC-21W	All Except F/M											
		AC-30W	All Except F/M											
		DC-8W	F & M											
		DC-30W	F & M											
		AC-21W	F & M											
		AC-30W	F & M											
	20D/30D	DC-8W	D											
		DC-30W	D											
		AC-21W	D											
		AC-30W	D											
	81/82	DC-8W	All Except F/M											
		DC-30W	All Except F/M											
	Soft Shift Valve	1, 4, 10, 11, 21, 22	DC-30W	All Except F/M										
			DC-30W	F & M										
2, 3/15, 5/16, 6, 7, 8, 9, 14, 20, 30		DC-30W	All Except F/M											
		DC-30W	F & M											
20D/30D		DC-30W	D											
81/82		DC-30W	All Except F/M											

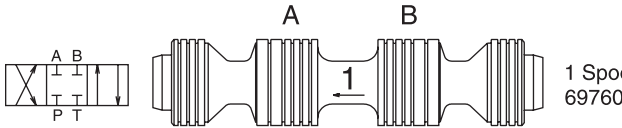
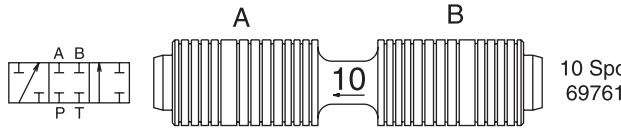
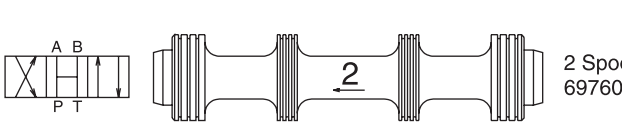
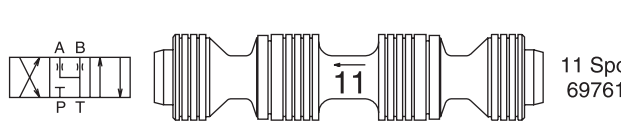
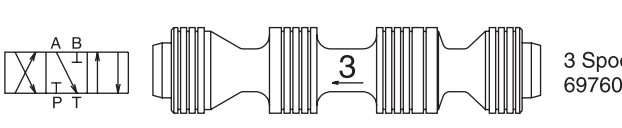
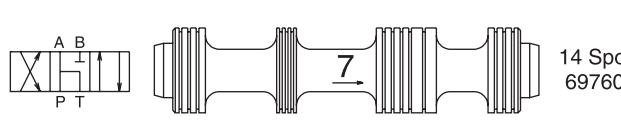
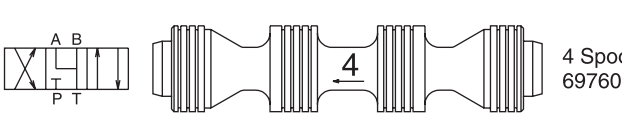
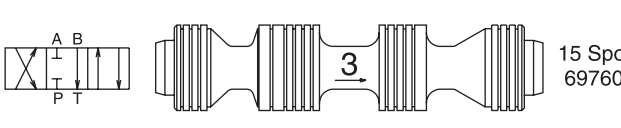
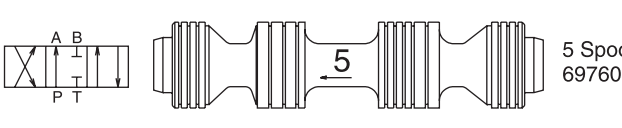
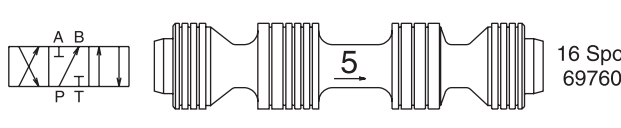
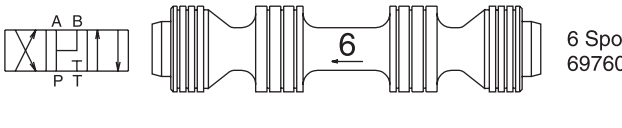
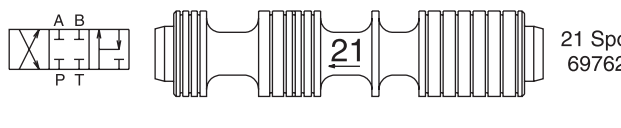
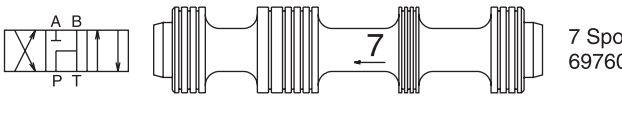
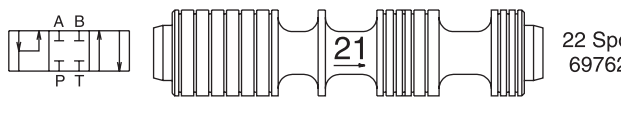
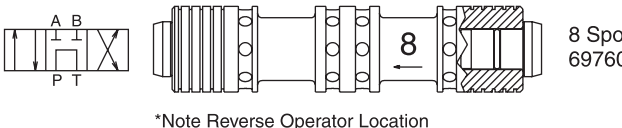
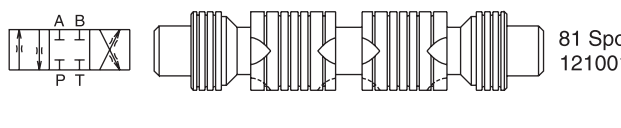
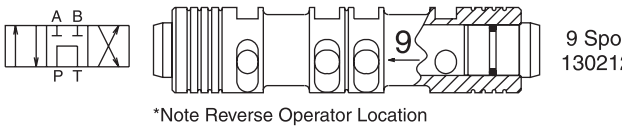
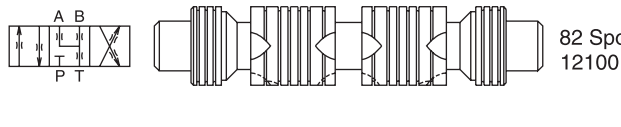
B-SOLENOID * (A-SOLENOID)	A-SOLENOID * (B-SOLENOID)	B-SOLENOID * (A-SOLENOID)	A-SOLENOID * (B-SOLENOID)
 <p>1 Spool 697601</p>	 <p>10 Spool 697610</p>		
 <p>2 Spool 697602</p>	 <p>11 Spool 697611</p>		
 <p>3 Spool 697603</p>	 <p>14 Spool 697607</p>		
 <p>4 Spool 697604</p>	 <p>15 Spool 697603</p>		
 <p>5 Spool 697605</p>	 <p>16 Spool 697605</p>		
 <p>6 Spool 697606</p>	 <p>21 Spool 697621</p>		
 <p>7 Spool 697607</p>	 <p>22 Spool 697621</p>		
 <p>8 Spool 697608</p> <p>*Note Reverse Operator Location</p>	 <p>81 Spool 1210011</p>		
 <p>9 Spool 1302128</p> <p>*Note Reverse Operator Location</p>	 <p>82 Spool 1210012</p>		

Variation 56 – Single Solenoid Plug-in Models with Lights and 3-Pin Manaplug (Mini)

Valve	Spool	Nameplate Marking	Wiring Diagram	Sol. Code	Item	Part Number	Qty	Description
D1VW	All Spools Except 008 and 009			A L L	1	1302151	1	Manaplug, 3-Pin
					2	1800707	1	Warning Label
					4	1800610-4	1	Conduit Box Cover
					5	1800611	1	Nameplate
D1VW	Spools 008 and 009 Only			A L L V O L T A G E S				
D1VW	All Spools Except 008 and 009							
D1VW	Spools 008 and 009 Only							

● Wiring diagrams show the backside of plug.

Variation 1C – Single Solenoid Plug-in Models with Lights and 5-Pin Manaplug (Mini)

Valve	Spool	Nameplate Marking	Wiring Diagram	Sol. Code	Item	Part Number	Qty	Description
D1VW	All Spools Except 008 and 009			A L L	1	1302154	1	Manaplug, 5-Pin
					2	697629	1	Warning Label
					4	1800610-4	1	Conduit Box Cover
					5	1800611	1	Nameplate
D1VHW	Spools 008 and 009 Only			A L L V O L T A G E S				
D1VHW	All Spools Except 008 and 009							
D1VW	Spools 008 and 009 Only							

● Wiring diagrams show the backside of plug.

Plug-in Conduit Variation

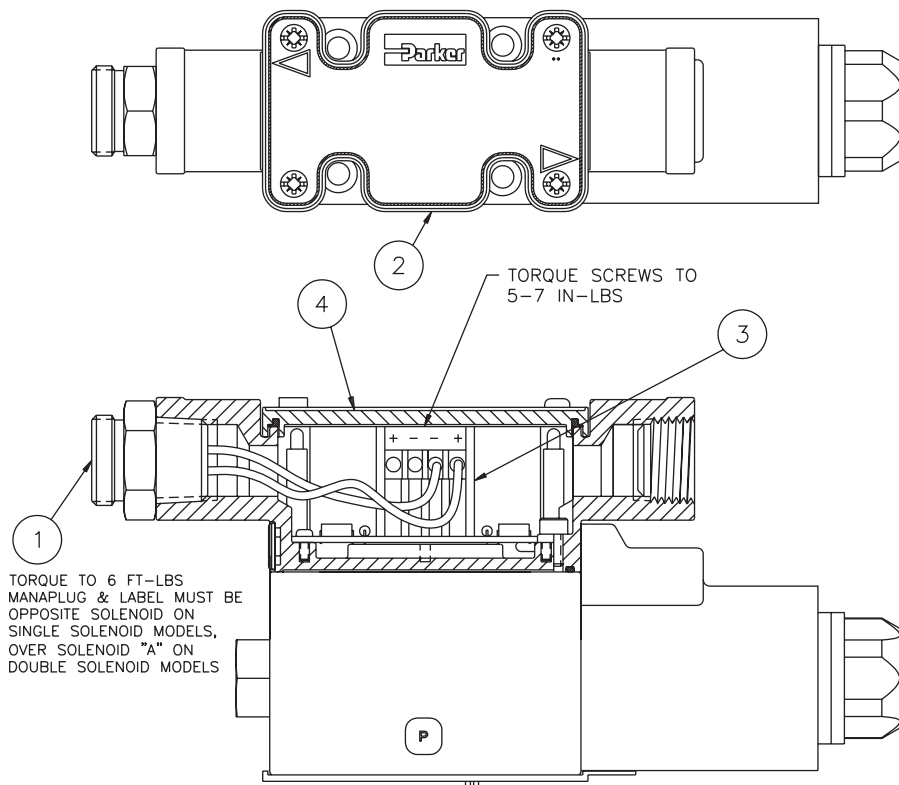

Note: H, K and M styles shown

Wiring Instructions

(Dashed lines indicate wiring thru terminal strip – no assembly required here)

1. Install manaplug (Item 1) over solenoid "A" on double solenoid models (opposite solenoid on single solenoid models).
2. Slip ground screw (1301070) through ring terminal on green ground wire (from manaplug) and secure to valve body.
3. Insert manaplug wires into terminal strip (Item 3) in box as shown in wiring diagram. Ensure all wire strands are contained by the connector and tighten clamping screws to 0.5 Nm (5 in. lbs.).
4. Install cover on the conduit box.
5. Place warning label (Item 2) on conduit box side, as shown.

Solenoid Ratings

Insulation System	Class F
Allowable Deviation from rated voltage	-15% to +10% for DC and AC rectified coils -5% to +5% for AC Coils
Armature	Wet pin type
CSA File Number	LR60407
Environmental Capability	DC Solenoids meet NEMA 4 and IP67 when properly wired and installed. Contact HVD for AC coil applications.

Explosion Proof Solenoid Ratings*

UL & CSA (EU)	Class I, Div 1 & 2, Groups C & D Class II, Div 1 & 2, Groups E, F & G As defined by the NEC
MSHA (EO)	Complies with 30CFR, Part 18
ATEX (ED)	Complies with ATEX requirements for: Exd, Group IIB; EN50014: 1999+ Amds. 1 & 2, EN50018: 2000

* Allowable Voltage Deviation $\pm 10\%$.

Note that Explosion Proof AC coils are single frequency only.

Code		Voltage	In Rush Amps Amperage	In Rush Amps D1VW VA	Holding Amps D1VW @ 3MM	Watts D1VW	Resistance D1VW
Voltage Code	Power Code						
D	L	120 VDC	N/A	N/A	0.09 Amps	10 W	1584.00 ohms
			N/A	N/A	0.26 Amps	30 W	528.00 ohms
G		198 VDC	N/A	N/A	0.15 Amps	30 W	1306.80 ohms
J	L	24 VDC	N/A	N/A	0.44 Amps	10 W	51.89 ohms
			N/A	N/A	1.32 Amps	30 W	17.27 ohms
K	L	12 VDC	N/A	N/A	0.88 Amps	10 W	12.97 ohms
			N/A	N/A	2.64 Amps	30 W	4.32 ohms
L	L	6 VDC	N/A	N/A	1.67 Amps	10 W	3.59 ohms
			N/A	N/A	5.00 Amps	30 W	1.20 ohms
Q	F	100 VAC / 60 Hz	1.70 Amps	170 VA	0.56 Amps	24 W	26.0 ohms
QD	F	100 VAC / 60 Hz	1.35 Amps	135 VA	0.41 Amps	18 W	31.2 ohms
QD	F	100 VAC / 50 Hz	1.50 Amps	150 VA	0.57 Amps	24 W	31.2 ohms
R	F	24/60 VAC, Low Watt	6.67 Amps	160 VA	2.20 Amps	23 W	1.52 ohms
T	F	240/60 VAC, Low Watt	0.70 Amps	168 VA	0.22 Amps	21 W	145.00 ohms
T	F	220/50 VAC, Low Watt	0.75 Amps	165 VA	0.26 Amps	23 W	145.00 ohms
U		98 VDC	N/A	N/A	0.10 Amps	30 W	960.00 ohms
Y	F	120/60 VAC, Low Watt	1.40 Amps	168 VA	0.42 Amps	21 W	36.50 ohms
Y	F	110/50 VAC, Low Watt	1.50 Amps	165 VA	0.50 Amps	23 W	36.50 ohms
Z	L	250 VDC	N/A	N/A	0.04 Amps	10 W	6875.00 ohms
			N/A	N/A	0.13 Amps	30 W	1889.64 ohms
Explosion Proof Solenoids							
R		24/60 VAC	7.63 Amps	183 VA	2.85 Amps	27 W	1.99 ohms
T		240/60 VAC	0.76 Amps	183 VA	0.29 Amps	27 W	1.34 ohms
N		220/50 VAC	0.77 Amps	169 VA	0.31 Amps	27 W	1.38 ohms
Y		120/60 VAC	1.60 Amps	192 VA	0.58 Amps	27 W	33.50 ohms
P		110/50 VAC	1.47 Amps	162 VA	0.57 Amps	27 W	34.70 ohms
Q		100/60 VAC	1.90 Amps	192 VA	0.70 Amps	27 W	38.60 ohms
K		12 VDC	N/A	N/A	2.75 Amps	33 W	4.36 ohms
J		24 VDC	N/A	N/A	1.38 Amps	33 W	17.33 ohms
D		120 VDC	N/A	N/A	0.28 Amps	33 W	420.92 ohms
Z		250 VDC	N/A	N/A	0.13 Amps	33 W	1952.66 ohms

Warning

Before any circuit connection is broken, be sure to turn off all power and relieve system pressure. Lower all vertical loads and cylinders, lock any load which could produce pressure and discharge any accumulators. Plug and cap all lines and openings to prevent contamination from entering the system.

Cleaning and Inspection

1. Proper cleaning is a critical part of preventive maintenance in the use of directional control valves. All parts should be cleaned with a solvent that is compatible with the system fluid. Compressed air may also work well when cleaning orifices and passage ways, but proper filtration must be employed to remove water and contamination.

NOTE: Always make sure all parts have been cleaned before reassembling.

2. Inspection

- a. Inspect all passage ways for obstructions.
 - b. Inspect all washers, push pins, plungers and pole faces for signs of wear and/or mushrooming. Inspect all springs for signs of distortion. Replace parts as necessary.
 - c. Look for nicks and burrs on the spool and bore lands. Nicks in these areas indicate likely contamination of the system fluid.
3. If there are no signs of nicks or burrs on the spool and bore, check the spool clearance as follows:
- a. Lubricate the spool and bore with clean system fluid.
 - b. Insert the spool back into the body and slowly move the spool back and forth. The spool should move freely. If there is any sticking between the spool and the bore, remove the spool and repeat 2b.
 - c. The spool clearance can also be checked by placing the valve body on end and inserting the spool. Gravity will pull the spool to the other end if there is no sticking.
 - d. After several attempts have been made without resolution, replace the valve.

Troubleshooting

Problem: Valve spool fails to move

	Cause	Recommendation
Mechanical	Recommended flow exceeded	Check maximum flow rate for appropriate spool by spool function.
	Recommended pressure exceeded	Check maximum pressure rating for valve.
	Improper installation connections	Check installation drawings.
	Contamination in system	Disassemble, inspect, clean and flush.
	Improper assembly	Check proper assembly. Refer to drawing for appropriate model.
	Valve has silted	Disassemble and clean valve.
Electrical	Power off	Turn power on.
	Improper voltage	Check voltage requirements for valve model.
	Faulty connection	Check connections.
	Faulty coil	Check coil resistance.

Problem: Valve produces undesirable response

	Cause	Recommendation
Mechanical	Recommended flow exceeded	Check maximum flow rate for appropriate spool by spool function.
	Recommended pressure exceeded	Check maximum pressure rating for valve.
	Improper installation connections	Check installation drawings.
	Contamination in system	Disassemble, inspect, clean and flush.
	Improper assembly	Check proper assembly. Refer to drawing for appropriate model.
	Improper fluid	Check fluid recommendations.
	Recommended temperature exceeded (indicated by fluid discoloration or spool tarnishing)	Check maximum temperature recommendations.
	Incorrect orifice size (soft shift only)	Check orifice size for desired response time.
Electrical	Improper voltage	Check voltage requirements for valve model.
	Faulty connection	Check connections.
	Faulty coil	Check coil resistance.

Terms of Sale with Warranty Limitations

Offer of Sale

The items described in this document and other documents or descriptions provided by Parker Hannifin Corporation, its subsidiaries and its authorized distributors are hereby offered for sale at prices to be established by Parker Hannifin Corporation, its subsidiaries and its authorized distributors. This offer and its acceptance by any customer ("Buyer") shall be governed by all of the following Terms and Conditions. Buyer's order for any such items, when communicated to Parker Hannifin Corporation, its subsidiary or an authorized distributor ("Seller") verbally or in writing, shall constitute acceptance of this offer.

1. Terms and Conditions of Sale: All descriptions, quotations, proposals, offers, acknowledgments, acceptances and sales of Seller's products are subject to and shall be governed exclusively by the terms and conditions stated herein. Buyer's acceptance of any offer to sell is limited to these terms and conditions. Any terms or conditions in addition to, or inconsistent with those stated herein, proposed by Buyer in any acceptance of an offer by Seller, are hereby objected to. No such additional, different or inconsistent terms and conditions shall become part of the contract between Buyer and Seller unless expressly accepted in writing by Seller. Seller's acceptance of any offer to purchase by Buyer is expressly conditional upon Buyer's assent to all the terms and conditions stated herein, including any terms in addition to, or inconsistent with those contained in Buyer's offer. Acceptance of Seller's products shall in all events constitute such assent.

2. Payment: Payment shall be made by Buyer net 30 days from the date of delivery of the items purchased hereunder. Amounts not timely paid shall bear interest at the maximum rate permitted by law for each month or portion thereof that the Buyer is late in making payment. Any claims by Buyer for omissions or shortages in a shipment shall be waived unless Seller receives notice thereof within 30 days after Buyer's receipt of the shipment.

3. Delivery: Unless otherwise provided on the face hereof, delivery shall be made F.O.B. Seller's plant. Regardless of the method of delivery, however, risk of loss shall pass to Buyer upon Seller's delivery to a carrier. Any delivery dates shown are approximate only and Seller shall have no liability for any delays in delivery.

4. Warranty: Seller warrants that the items sold hereunder shall be free from defects in material or workmanship for a period of 18 months from date of shipment from Parker Hannifin Corporation. **THIS WARRANTY COMPRISES THE SOLE AND ENTIRE WARRANTY PERTAINING TO ITEMS PROVIDED HEREUNDER. SELLER MAKES NO OTHER WARRANTY, GUARANTEE, OR REPRESENTATION OF ANY KIND WHATSOEVER. ALL OTHER WARRANTIES, INCLUDING BUT NOT LIMITED TO, MERCHANTABILITY AND FITNESS FOR PURPOSE, WHETHER EXPRESS, IMPLIED, OR ARISING BY OPERATION OF LAW, TRADE USAGE, OR COURSE OF DEALING ARE HEREBY DISCLAIMED. NOTWITHSTANDING THE FOREGOING, THERE ARE NO WARRANTIES WHATSOEVER ON ITEMS BUILT OR ACQUIRED WHOLLY OR PARTIALLY, TO BUYER'S DESIGNS OR SPECIFICATIONS.**

5. Limitation Of Remedy: SELLER'S LIABILITY ARISING FROM OR IN ANY WAY CONNECTED WITH THE ITEMS SOLD OR THIS CONTRACT SHALL BE LIMITED EXCLUSIVELY TO REPAIR OR REPLACEMENT OF THE ITEMS SOLD OR REFUND OF THE PURCHASE PRICE PAID BY BUYER, AT SELLER'S SOLE OPTION. IN NO EVENT SHALL SELLER BE LIABLE FOR ANY INCIDENTAL, CONSEQUENTIAL OR SPECIAL DAMAGES OF ANY KIND OR NATURE WHATSOEVER, INCLUDING BUT NOT LIMITED TO LOST PROFITS ARISING FROM OR IN ANY WAY CONNECTED WITH THIS AGREEMENT OR ITEMS SOLD HEREUNDER, WHETHER ALLEGED TO ARISE FROM BREACH OF CONTRACT, EXPRESS OR IMPLIED WARRANTY, OR IN TORT, INCLUDING WITHOUT LIMITATION, NEGLIGENCE, FAILURE TO WARN OR STRICT LIABILITY.

6. Changes, Reschedules and Cancellations: Buyer may request to modify the designs or specifications for the items sold hereunder as well as the quantities and delivery dates thereof, or may request to cancel all or part of this order, however, no such requested modification or cancellation shall become part of the contract between Buyer and Seller unless accepted by Seller in a written amendment to this Agreement. Acceptance of any such requested modification or cancellation shall be at Seller's discretion, and shall be upon such terms and conditions as Seller may require.

7. Special Tooling: A tooling charge may be imposed for any special tooling, including without limitation, dies, fixtures, molds and patterns, acquired to manufacture items sold pursuant to this contract. Such special tooling shall be and remain Seller's property notwithstanding payment of any charges by Buyer. In no event will Buyer acquire any interest in apparatus belonging to Seller which is utilized in the manufacture of the items sold hereunder, even if such apparatus has been specially converted or adapted for such manufacture and notwithstanding any charges paid by Buyer. Unless otherwise agreed, Seller shall have the right to alter,

discard or otherwise dispose of any special tooling or other property in its sole discretion at any time.

8. Buyer's Property: Any designs, tools, patterns, materials, drawings, confidential information or equipment furnished by Buyer or any other items which become Buyer's property, may be considered obsolete and may be destroyed by Seller after two (2) consecutive years have elapsed without Buyer placing an order for the items which are manufactured using such property. Seller shall not be responsible for any loss or damage to such property while it is in Seller's possession or control.

9. Taxes: Unless otherwise indicated on the face hereof, all prices and charges are exclusive of excise, sales, use, property, occupational or like taxes which may be imposed by any taxing authority upon the manufacture, sale or delivery of the items sold hereunder. If any such taxes must be paid by Seller or if Seller is liable for the collection of such tax, the amount thereof shall be in addition to the amounts for the items sold. Buyer agrees to pay all such taxes or to reimburse Seller therefore upon receipt of its invoice. If Buyer claims exemption from any sales, use or other tax imposed by any taxing authority, Buyer shall save Seller harmless from and against any such tax, together with any interest or penalties thereon which may be assessed if the items are held to be taxable.

10. Indemnity For Infringement of Intellectual Property Rights: Seller shall have no liability for infringement of any patents, trademarks, copyrights, trade dress, trade secrets or similar rights except as provided in this Part 10. Seller will defend and indemnify Buyer against allegations of infringement of U.S. Patents, U.S. Trademarks, copyrights, trade dress and trade secrets (hereinafter 'Intellectual Property Rights'). Seller will defend at its expense and will pay the cost of any settlement or damages awarded in an action brought against Buyer based on an allegation that an item sold pursuant to this contract infringes the Intellectual Property Rights of a third party. Seller's obligation to defend and indemnify Buyer is contingent on Buyer notifying Seller within ten (10) days after Buyer becomes aware of such allegations of infringement, and Seller having sole control over the defense of any allegations or actions including all negotiations for settlement or compromise. If an item sold hereunder is subject to a claim that it infringes the Intellectual Property Rights of a third party, Seller may, at its sole expense and option, procure for Buyer the right to continue using said item, replace or modify said item so as to make it noninfringing, or offer to accept return of said item and return the purchase price less a reasonable allowance for depreciation. Notwithstanding the foregoing, Seller shall have no liability for claims of infringement based on information provided by Buyer, or directed to items delivered hereunder for which the designs are specified in whole or part by Buyer, or infringements resulting from the modification, combination or use in a system of any item sold hereunder. The foregoing provisions of this Part 10 shall constitute Seller's sole and exclusive liability and Buyer's sole and exclusive remedy for infringement of Intellectual Property Rights.

If a claim is based on information provided by Buyer or if the design for an item delivered hereunder is specified in whole or in part by Buyer, Buyer shall defend and indemnify Seller for all costs, expenses or judgments resulting from any claim that such item infringes any patent, trademark, copyright, trade dress, trade secret or any similar right.

11. Force Majeure: Seller does not assume the risk of and shall not be liable for delay or failure to perform any of Seller's obligations by reason of circumstances beyond the reasonable control of Seller (hereinafter 'Events of Force Majeure'). Events of Force Majeure shall include without limitation, accidents, acts of God, strikes or labor disputes, acts, laws, rules or regulations of any government or government agency, fires, floods, delays or failures in delivery of carriers or suppliers, shortages of materials and any other cause beyond Seller's control.

12. Entire Agreement/Governing Law: The terms and conditions set forth herein, together with any amendments, modifications and any different terms or conditions expressly accepted by Seller in writing, shall constitute the entire Agreement concerning the items sold, and there are no oral or other representations or agreements which pertain thereto. This Agreement shall be governed in all respects by the law of the State of Ohio. No actions arising out of the sale of the items sold hereunder or this Agreement may be brought by either party more than two (2) years after the cause of action accrues.

9/91-P



Parker Hannifin Corporation
Hydraulic Valve Division
520 Ternes Avenue
Elyria, Ohio, 44035 USA
Tel: (440) 366-5200
Fax: (440) 366-5253
www.parker.com/hydraulicvalve

Bulletin HY14-2536-M5/US,
600, 4/07, PHD