

PROFINET™ Supplemental Manual

SLA5800 & SLAMf Series Digital Mass Flow Controllers & Meters

BROOKS®
INSTRUMENT

Beyond Measure

ESSENTIAL INSTRUCTIONS

Read this page before proceeding

Brooks Instrument designs, manufactures and tests its products to meet many national and international standards. Because these instruments are sophisticated technical products, you must properly install, use and maintain them to ensure they continue to operate within their normal specifications. The following instructions must be adhered to and integrated into your safety program when installing, using and maintaining Brooks Products.

- Read all instructions prior to installing, operating and servicing the product. If this instruction manual is not the correct manual, please see back cover for local sales office contact information. Save this instruction manual for future reference
- If you do not understand any of the instructions, contact your BrooksInstrument representative for clarification
- Follow all warnings, cautions and instructions marked on and supplied with the product
- Inform and educate your personnel in the proper installation, operation and maintenance of the product
- Install your equipment as specified in the installation instructions of the appropriate instruction manual and per applicable local and national codes. Connect all products to the proper electrical and pressure sources.
- To ensure proper performance, use qualified personnel to install, operate, update, program and maintain the product
- When replacement parts are required, ensure that qualified people use replacement parts specified by Brooks Instrument.
- Unauthorized parts and procedures can affect the product's performance and place the safe operation of your process at risk. Look-alike substitutions may result in fire, electrical hazards or improper operation.
- Ensure that all equipment doors are closed and protective covers are in place, except when maintenance is being performed by qualified persons, to prevent electrical shock and personal injury.

ESD (Electrostatic Discharge)

⚠ CAUTION

This instrument contains electronic components that are susceptible to damage by electricity. Proper handling procedures must be observed during the removal, installation, or other handling of internal circuit boards or devices

Handling Procedure:

1. Power to the unit must be removed
2. Personnel must be grounded, via a wrist strap or other safe, suitable means before any printed circuit card or other internal device is installed, removed or adjusted.
3. Printed circuit cards must be transported in a conductive container. Boards must not be removed from protective enclosure until immediately before installation. Removed boards must immediately be placed in protective container for transport, storage or return to factory.

Comments:

This instrument is not unique in its content of ESD (electrostatic discharge) sensitive components. Most modern electronic designs contain components that utilize metal oxide technology (NMOS, SMOS, etc.). Experience has proven that even small amounts of static electricity can damage or destroy these devices. Damaged components, even though they appear to function properly, exhibit early failure.

Contents

Section 1 Introduction

General Information	1
---------------------------	---

Section 2 Installation

Definition of Terms	2
---------------------------	---

Section 3 Before Starting

Before Starting.....	3
Background & Assumptions.....	3
Compliance.....	3
Notations	3
Numbers.....	3
EPATHS.....	3

Section 4 Quick Start

Physical Interfaces	4
Communications I/O SLAMf	5
Power Supply SLAMf.....	6
Power Supply & Communications SLA5800	7
Communications Notes: SLA5800 & SLAMf	10
MOD LED	10
NET LED.....	11
TC/IP Network Configuration.....	11
Module/Slot Configuration	12

Section 5 Configuration

Commonly Configured Parameters	13
Data Units.....	14
Safe Modes	15
Valve Safe Mode.....	15
Process Gas Page Configuration	15
Module: I/O Data	16
Module: Device Management.....	17
Module: Flow Meter	17
Module: Flow Controller.....	18
Module: Valve Drive.....	18
Module: Temperature Meter.....	19
Module: Process Gas	19
Module: Status.....	19

Section 6 Detailed Configuration

Overview.....	20
Device Management Module [0x01]	20
Parameters	20
Flow Meter Module [0x02]	23
Parameters	23
Valve Driver Module [0x04].....	29
Parameters	29
Flow Controller Module [0x03].....	32
Parameters	32
Process Gas Module [0x06]	34
Parameters	34
Temperature Meter Module [0x05].....	35
Parameters	35
Status Module [0x07].....	36
Parameters	36

Contents

Section 7 Status

Device Status	39
Bit 0: Device is Executing	39
Bit 1: Flow Reading Valid	40
Bit 2: Temperature Reading Valid	40
Bit 3: Device is Zeroing	40
Bit 4: Zero Recommended	40
Condition 1: Zero Warn Time Expired	41
Condition 2: Zero Out of Tolerance	41
Bit 5: Zero Operation Inhibit	42
Bit 6: Valve Override	42
Bit 7: Control Override	43
Bit 8: Service Error	43
Bit 9: Device Alarm	43
Bit 10: Device Warning	43
Bit 11: Zero Button Disabled	44
Bit 12: Control Ramping	44
Warnings	45
Bit 0: Low Flow Warning	45
Bit 1: High Flow Warning	45
Bit 3: Choked Flow Warning	46
Bit 4: Excessive Zero Drift Warning	47
Bit 5: Bad Zero Warning	48
Bit 8: Valve High Warning	49
Bit 9: Valve Low Warning	49
Bit 10: Valve Control Warning	49
Bit 11: Setpoint Deviation	50
Bit 13: Setpoint Over range	51
Bit 14: Setpoint Limited	52
Bit 17: Calibration Due	53
Bit 18: Totalizer Overflow	53
Bit 19: Overhaul Due	53
Bit 24: High Temperature Warning	54
Bit 25: Low Temperature	54
Bit 26: Supply Volts High	54
Bit 27: Supply Volts Low	55
Alarms	56
Bit 0: Low Flow Alarm	56
Bit 1: High Flow Alarm	56
Bit 2: No Flow Alarm	57
Bit 3: Choked Flow Alarm	58
Bit 15: Invalid Process Gas Page Selected	59
Bit 23: Using Backup NV Memory	59
Bit 24: Temperature Sensor Fail	59
Errors	60
Bit 2: Back Streaming Error	60
Bit 18: Internal Communication Error	60
Bit 23: NV Memory Fail	60
Typical Status High/Low Processing	61

Contents

Section 8 Troubleshooting

Troubleshooting 62

Section 9 Appendix

Appendix A..... 63

Appendix B- Data Type Definitions 63

Appendix C- Data Units 64

Section 10 Glossary

Glossary 66

Contents

Figure Number

4-1	Pin Labeling of M12 Female Connectors (2 per device).....	5
4-2	Layout Under Top Cover.....	5
4-3	Device side view with M12 Power connector.....	6
4-4	PROFINET Top Cover SLA5800	7
4-5	M8 Male Device Connector Pin Layout, Pin Side View SL5800.....	7
4-6	M8 Female Mating Cable.....	8
4-7	M8 Pin Layout.....	8
4-8	M12 Power Cable	9

Contents

Table Number

2-1	Calibration Object Attributes	2
4-1	Pin function of M12 Female Connectors (2 per device).....	5
4-2	Pin Labeling of M12 Male Device and Female Mating Cable Connector SLAMf.....	6
4-3	Pin Labeling of M8 Male Device and Female Mating Cable Connector SLA5800.....	7
4-4	Wire Labeling of M8 Female Mating Cable Connector	8
4-5	M8 Female Mating Cable Part Numbers	9
4-6	M12 Cable Connector Pinout.....	9
4-7	M12 Female Mating Cable Part Numbers	9
4-8	MOD LED Indicator Definitions.....	10
4-9	NET LED Indicator Definitions.....	11
4-10	MFC Module/Slot Configuration.....	12
4-11	MFM Module/Slot Configuration	12
5-1	Commonly Configured Parameters/Parameters.....	14
5-2	Configurable Data Units Parameters	14
5-3	Safe State	15
5-4	MFC Modules	16
5-5	MFM Modules.....	16
5-6	Device Management Module Inputs	17
5-7	Flow Meter Module Inputs	17
5-8	Flow Meter Module Outputs.....	17
5-9	Flow Controller Module Inputs.....	18
5-10	Flow Controller Module Outputs.....	18
5-11	Valve Driver Module Inputs.....	18
5-12	Valve Driver Module Outputs.....	18
5-13	Valve Driver Module Inputs.....	19
5-14	Process Gas Module Inputs.....	19
5-15	Process Gas Module Inputs.....	19
6-1	Device Manager Parameters	20
6-2	Flow Meter Module Parameters.....	23
6-3	Valve Driver Module Parameters	29
6-4	Override	30
6-5	Safe State	31
6-6	Flow Controller Module Parameters	32
6-7	Setpoint Limiting Actions.....	33
6-8	Setpoint Limiting Actions.....	33
6-9	Process Gas Module Parameters.....	34
6-10	Temperature Meter Module Parameters	35
6-11	Status Module Parameters	36
6-12	Active Error Bit Definitions	36
6-13	Active Alarms Bit Definitions	36
6-14	Active Warnings Bit Definitions	37
6-15	Device Status Bit Definitions.....	38

Section 1: General Information

Many applications of Flow Controllers/Meters are moving to increase the use of automation. Automation comes in many forms: PLC's (Programmable Logic Controllers, like those from Allen/Bradley, DCS's (Distributed Control Systems, such as Emerson's DeltaV), PC-based solutions (National Instruments LabVIEW™), and Ethernet based field buses. Digital communications from these varied systems and the devices they measure and control, are a very effective means of not only accomplishing more effective and rapid system integration, but also providing greatly improved system diagnostics and maintainability.

PROFINET™ is an Ethernet-based communications system for industrial automation applications built upon the IEEE 802 standards for Ethernet and is standardized in IEC 61158 and IEC 61784. PROFINET™ incorporates elements of TCP/IP communications standards and has defined its own messaging protocols to minimize latencies TCP/IP protocols introduce. This solution leverages the power of the internet and enterprise connectivity, combined with the functionality and comprehensive suite of messages and services for manufacturing automation applications. The PROFINET™ interface is now available on SLA Series.

Section 2 Definition of Terms

Table 2-1 Definitions

Abbreviation	Description
Byte	A Byte refers to 8 consecutive bits.
CRC	Checksum (Cyclic Redundancy Check)
PNET	PROFINET
GSDML	XML Format of General Station Description file
LSB	Least Significant Bit or Least Significant Byte
MAC	Media Access Control is responsible for address checking and is most often done in the hardware of a NIC.
Master	A Master is a unit which controls the Slaves, feeding them commands and receiving status reports in exchange.
MFC/MFM	Mass Flow Controller / Mass Flow Meter
MSB	Most Significant Bit or Most Significant Byte
MTU	Maximum Transmission Unit. The maximum payload that a standard Ethernet Frame can hold. The MTU is set at 1500 bytes (Not considering the Header and Checksum).
NIC	Network Interface Controller. A hardware component that connects a computer to a network.
NV	Non-Volatile
OSI Model	A standardized representation for how a communication system can be organized. (e.g., a protocol stack) The model is divided into layers, each responsible for a part of the communication.
RO	Read Only
RT	Real-time. A system that adheres to strict timing demands.
RW	Read / Write
Slave	A Slave is a unit (node) on the network (e.g., an MFC). The Slave is connected to a Master.
Stack	A synonym for the implementation of the layers of a protocol.
TCP/IP	Transport Control Protocol/Internet Protocol
Topology	The way a network (Master & Slaves) is inter-connected. The overall layout. (e.g., Star, Tree, Line Topology)
WO	Write Only
DLR	Device Level Ring

Section 3 Before Starting

Background & Assumptions

This manual is a supplement to the SLA Series 5800 and MF Mass Flow Controller Installation and Operation Manuals. It is recommended that the owner read the Operations Manual first before continuing with this supplement.

This manual assumes the user has a basic knowledge and understanding of the PROFINET™ protocol, its topology and its method of logically accessing the data or parameters contained within a device. This manual also assumes basic knowledge and understanding regarding the operation of Mass Flow Controllers or Mass Flow Meters. This manual is not intended to be a replacement to the IEC specifications, which is still the authoritative definition and description of PROFINET™ communications. It is recommended, but not required for the purposes of this manual, that the user obtain relevant specification and application information for PROFINET from Profi-International (PI) at <http://www.profibus.com>.

This manual does not make any assumptions about any manufacturer of equipment or custom software used by the user to communicate with the Brooks Instrument device but assumes the user has thorough understanding of such equipment and any configuration software.

Compliance

The SLA Series Mass Flow Controller (MFC) or Mass Flow Meter (MFM) is a conformance class B PROFINET IO device and conforms to PI specifications.

Notations

This section details notations and conventions used throughout the manual. It is recommended that the reader become very familiar with these conventions.

Hypertext links are used in the manual to assist in navigating.

A glossary is provided for reference in Section: 10 Glossary to aid in reviewing and/or to define any unfamiliar terms.

Numbers

Numeric values used throughout this manual will be clearly denoted as to the base numeric system it represents. All hexadecimal numbers (base 16) will be prefixed with a 0x, like 0xA4. All binary numbers (base 2) will be suffixed with a b, like 1001b. All other numbers not annotated this way will be assumed decimal (base 10).

EPATHS

EPATH's will be denoted within brackets [] or braces {}, like [0x31, 1, 3], {0x31-1-3} which represents, left to right, the Slot (hexadecimal or decimal), Subslot (decimal), and Index (decimal)

Section 4 Quick Start

This section assumes that the owner of the Digital Series device has a fully operational and trouble-free communications network with appropriate power supplies. This section also assumes that a master device or application is connected to the network, capable of cyclic I/O and acyclic message communications. Both types of data communication modes are supported by the SLA Series PROFINET™ device.

Physical Interfaces

The available physical interfaces on the PROFINET™ SLAMF Device are listed below (outer cover unless noted otherwise):

- In and Out M12 threaded female connectors labeled “1” and “2” for PROFINET™ Communications (Figure 4-1).
- 2.5 mm female jack for RS485 diagnostic port, which is located either under the top cover (SLAMf IP-66 only versions) or under the access screw on the inlet side of the device, just above the M12 power connection (shown in Figure 4-3).
- 4 pin M12 threaded Male (Euro Lock) Connector for power labeled “PWR” (figure 4-3).
- Note that earlier versions of the SLAMf IP66 (only) devices were equipped with M8 power connectors. Diagrams for these connectors can be found in the SLAMf Series Elastomer Sealed, Thermal Mass Flow Meters and Controllers Instruction and Operations Manual (IOM).

The available physical interfaces on the PROFINET™ SLA5800 Device are listed below (Figure 4-4):

- 5pin M8 threaded male connector for power labeled "PWR"
- In and Out RJ-45 connectors labeled “1” and “2” for PROFINET™ Communications
- 2.5mm female jack for RS485 diagnostic port labeled ‘DIAG’, refer to the SLA Series Installation and Operation Manual for more details.

Section 4 Quick Start

Communications I/O SLAMF

Digital I/O needs to be supplied via the M12 Connector, see Table 4-1.

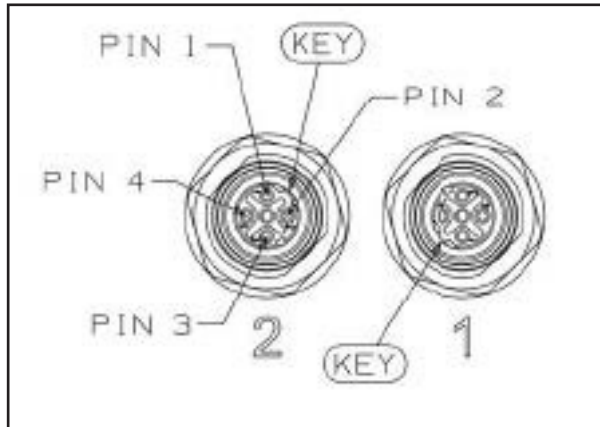

Figure 4-1 Pin Labeling of M12 Female Connectors (2 per device)

Connector	Function
1	TD+
2	RD+
3	TD-
4	RD-

Table 4-1 Pin function of M12 Female Connectors (2 per device)

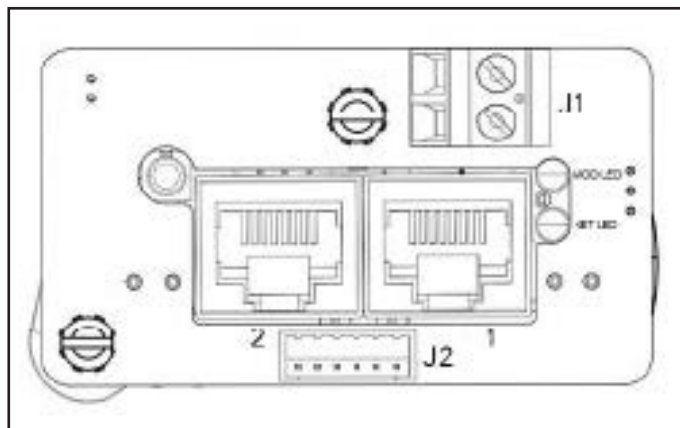

Figure 4-2 SLAMf Hazardous Area Device Layout Under Top Cover

Section 4 Quick Start

Power Supply SLAMF

Power needs to be supplied via the M12 connector.

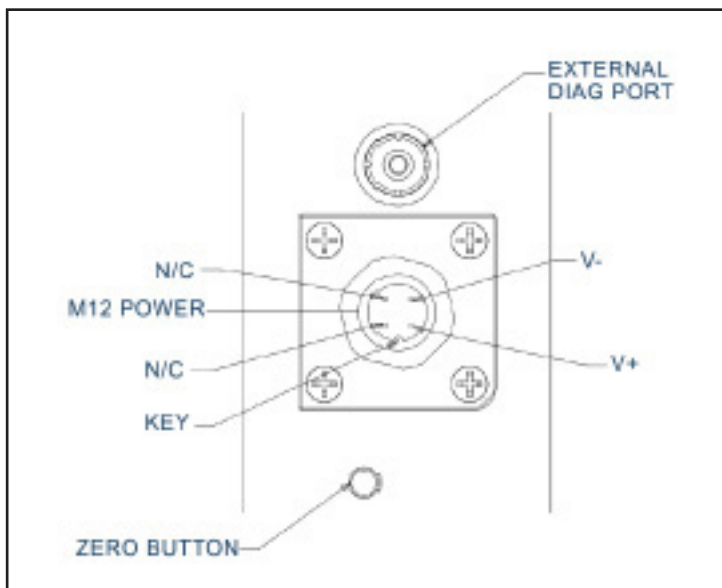

Figure 4-3 SLAMf Hazardous Area device side view with M12 Power connector

Table 4-2: Pin Labeling of M12 Male Device and Female Mating Cable Connector SLAMf

Pin Label	Function at Remote Connector
V+	Positive Power Supply Voltage
V-	Power Supply Ground
N/C	Not Connected

Section 4 Quick Start

Power Supply & Communications SLA5800

Power needs to be supplied via the M8 connector. See Table 4-3.

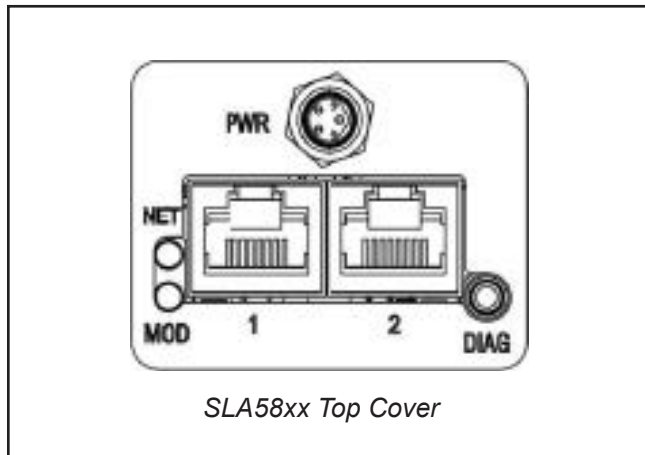

Figure 4-4: PROFINET Top Cover SLA5800

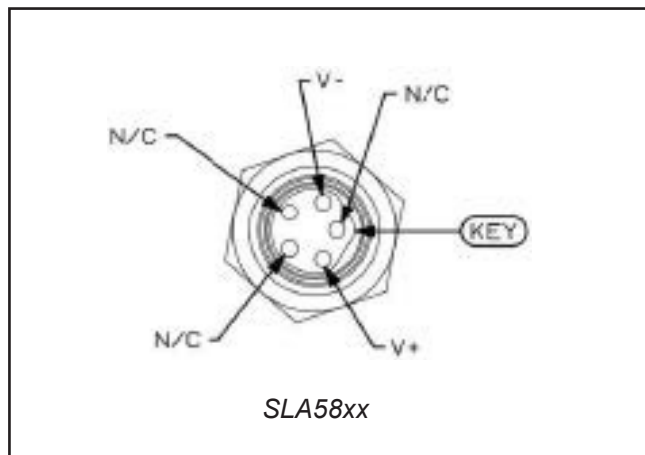

Figure 4-5: M8 Male Device Connector Pin Layout, Pin Side View SLA5800

Table 4-3: Pin Labeling of M8 Male Device and Female Mating Cable Connector SLA5800

Pin Label	Function at Remote Connector
V+	Positive Power Supply Voltage
V-	Power Supply Ground
N/C	Not Connected

Section 4 Quick Start

M8 & M12 mating cable details.

Mating Cables can be purchased as a second line item as below.

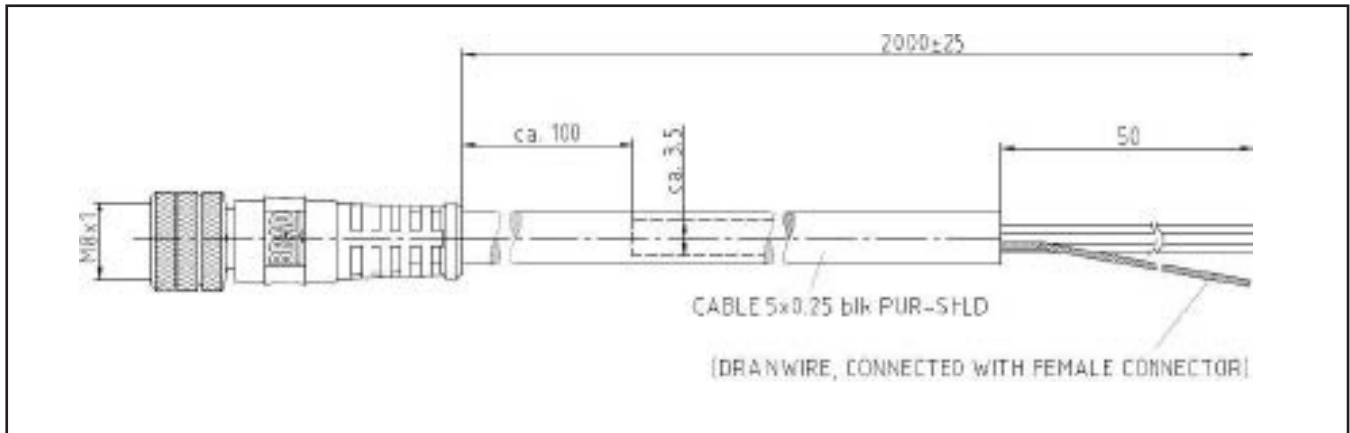

Figure 4-6: M8 Female Mating Cable

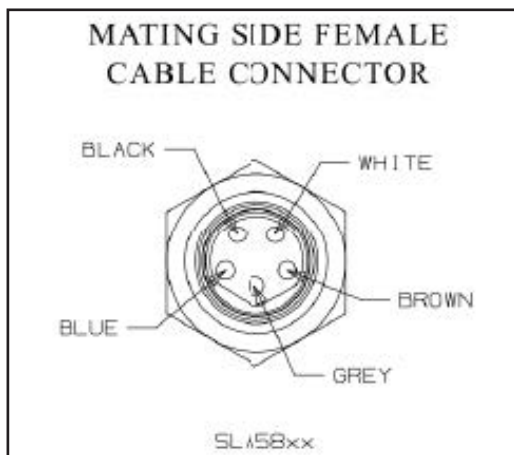

Figure 4-7: M8 Pin Layout

Table 4-4: Wire Labeling of M8 Female Mating Cable Connector

Wire Color	Wire Label	Function at Remote Connector
Blue	V	Power Supply Ground
Brown	V+	Positive Power Supply Voltage
Black	N/C	Not Connected
White	N/C	Not Connected
Grey	N/C	Not Connected

Table 4-5: M8 Female Mating Cable Part Numbers

Supplier	Part Number	Description
Brooks Instrument	124X049AAA	M8 Mating Cable 2m
	124X050AAA	M8 Mating Cable 5m
	124Z170AAA	ECAT to DB15 Male

Section 4 Quick Start

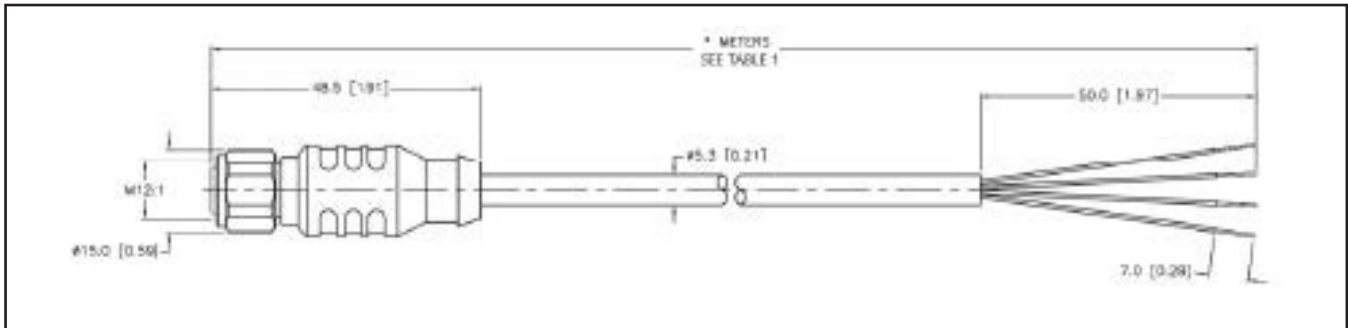

Figure 4-8: M12 Power Cable

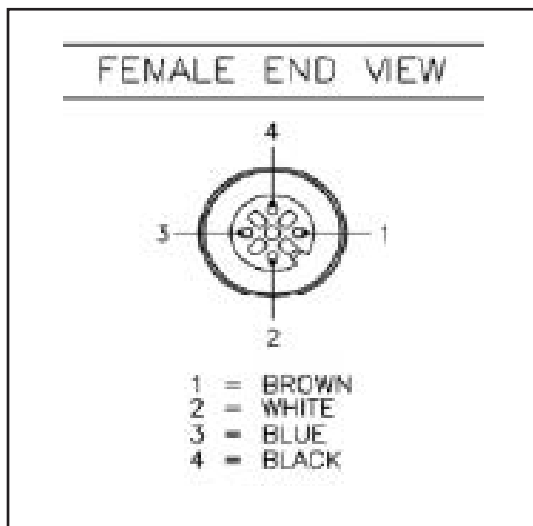

Figure 4-9: M12 Cable Female Connector End view

Table 4-6: M12 Cable Connector Pinout

Wire Color	Wire Label	Function
Brown	N/C	Not Connected
White	V+	Positive Power Supply Voltage
Blue	V-	Power Supply Ground
Black	N/C	Not Connected

Table 4-7: M12 Female Mating Cable Part Numbers

Supplier	Part Number	Description
Brooks Instrument	124X309AAA	M12 Power, C1D2, 2m
	124X310AAA	M12 Power, C1D2, 3m
	124Z311AAA	M12 Power, C1D2, 8m
	124Z312AAA	M12 Power, C1D2, 15m

Section 4 Quick Start

COMMUNICATIONS NOTES: SLA5800 & SLAMf

As noted in the Physical Interface Sections, above, each SLAMf device has (2) M12 4 Pole, Female “D” Coded Connectors (Figure 4-1) labeled 1 and 2. Network connections can be made to either, or both, ports, depending on the network topology. And each SLA5800 Series PROFINET™ device has (2) RJ-45 Ethernet Connection ports (Figure 4-4). The SLA5800/SLAMf Series PROFINET™ device will support star and linear. It does not support DLR (Device Level Ring) topology.

The SLA5800/SLAMf Series PROFINET™ device supports auto-negotiation of the communications link. Both ports support data rates of 10/100 Mbps and Half/Full duplex communications. The device may be directly connected to the Ethernet NIC on a desktop or laptop PC for configuration and commissioning activities.

MOD LED

Table 4-8: MOD LED Indicator Definitions

Indicator State	Summary	Requirement
Off	No power	No power is supplied to the device.
Solid Green	Device Operational	Device is operating correctly.
Flashing Green	Standby	Device has not been configured.
Fast Flashing Green	LED Blink	The LED Blink command has been received by the device. The NET LED will also flash at the same rate.
Flashing Red	Major Recoverable Fault	The device has detected a Major Recoverable Fault (Alarm) The alarm must be enabled for the LED to flash red.
Red	Major Unrecoverable Fault	The device has detected a Major Unrecoverable fault (Error)
Flashing Green / Red	Self-test	The device is performing its power-up testing.

Section 4 Quick Start

NET LED

Table 4-9: NET LED Indicator Definitions

Indicator State	Summary	Requirement
Off	No power Or No Name	The device is powered off or is powered on but with no IP address configured
Flashing Green	No connections	The Name has been set but no cyclic communications has been established with the device by the master/controller.
Steady Green ¹	Connected	A PROFINET™ name is configured, and cyclic communications has been established between the controller and the device
Flashing Green / Red	Self-test	The device is performing its power-up testing.

1). When the ProfiNET name is a duplicate with another device, and the IP is different or when both the IP address and PROFINET name are duplicates, note that if one of the devices is connected to the BEST software tool, it will lock up. If this happens, please reconfigure the devices to have different names/addresses.

TCP/IP Network Configuration

The TCP/IP network settings can be configured using a web browser interface or through the PROFINET networking tools. By default, SLA Series PROFINET MFC/MFM is shipped with the following factory configuration:

IP Address: 192.168.1.100

NET Mask: 255.255.255.0

Name: brooks-sla

To configure using a web browser, connect the device to the network that is configured with the same subnet as the device (192.168.1.xxx). Open the web browser and enter the IP address of the device as the URL

The Web Interface opens in read-only mode. To change the configuration, click the Login Tab. From the pulldown, select Configure or Control. The default password for Configure is 'configure'. The default password for Control is 'control'.

Section 4 Quick Start

Module/Slot Configuration

Load the latest GSDML file for SLA Series mass flow devices into the PROFINET configuration tool. This file can be downloaded from the Brooks Instrument website. Add the appropriate MFC/MFM device into the network configuration.

For basic operation of the MFC/MFM, the following modules will need to be configured into slots for the device:

MFC*Table 4-10: MFC Module/Slot Configuration*

Module Name	Slot	Variable	I/Q	Data Type	Default Eng Units
Flow Meter	2	Flow	Input(I)	REAL	Percent
Flow Controller	3	Setpoint	Output(Q)	REAL	Percent

MFM*Table 4-11: MFM Module/Slot Configuration*

Module Name	Slot	Variable	I/Q	Data Type	Default Eng Units
Flow Meter	2	Flow	Input(I)	REAL	Percent

MFC devices at a minimum require Setpoint (CV) to command the device to flow and Flow (PV) as input for indicated flow.

MFM devices only require Flow (PV) as an input for indicated flow

Modules with suffixes ‘..w/o Config’ will not send configuration data to the device during the phase when the master/control established cyclic connection with the device. See Section 5: Configuration on methods of configuring SLA Series MFC/MFM's.

Section 5 Configuration

Section 5: Configuration

Commonly Configured Parameters

PROFINET™ provides several ways to configure a device. As noted in the previous sections, modules can be selected that have module configuration data associated with them such that the device is configured when the master/controller establishes a cyclic connection with the device. Alternatively, modules with no configuration data can be used, and separate Read/Write record messages can be used for configuring module parameters.

The SLA Series PROFINET™ devices also contains an embedded web interface for configuration and troubleshooting. To access the web interface, see section '**TCP/IP Network Configuration**' in this manual.

The Brooks Expert Support Tool (BEST) downloadable software is the most comprehensive commissioning, configuration and troubleshooting tool for SLA Series PROFINET devices. Servicing tasks include setup, attribute configuration, diagnostics, troubleshooting and valve tuning. Calibration is available with a license key.

The SLA Series MFC/MFM supports many different configurable parameters. The out-of-box defaults meet the needs of a great majority of applications, but some applications may require the device to report more information or behave differently than is configured with default settings, such as valve position, safe mode, flow and/or setpoint engineering units, etc.

This section covers the more common parameters that are configured to meet the unique needs of applications. The terms "parameter" and "parameters" can be used interchangeably and ultimately refer to the same data item within the MFC device.

The following tables will reference both the Parameter name and the EPATH descriptor (slot-subslot-index) for those who want to use Read/Write record messages to configure the device.

Section 5 Configuration

Table 5-1: Commonly Configured Parameters/Parameters

Parameter	EPATH	Default	Semantics
Flow Meter Data Units	2	Flow	Input(l)
Flow Controller Data Units	[0x02-1-4]	4103 (0x1007)	See Next Section Data Units
Temperature Meter Data	[0x03-1-4]	4103 (0x1007)	See Next Section Data Units
Selected Gas	[0x05-1-4]	4608 (0x1200)	See Next Section Data Units
Calibration	[0x02-1-35]	1	The subplot representing the Process Gas Calibration used to linearize the Flow Sensor
Valve Driver Safe State	[0x04-1-21]	0 (Close)	The valve will close when the device is in its Safe State
Status Alarm Mask	[0x07-1-8]	0x00000000	All Alarm Bits are masked
Status Warning Mask	[0x07-1-9]	0x00000000	All Warning Bits are masked

Data Units

The SLA Series MFC can report flow and accept setpoints in values associated to engineering units. This can simplify user interpretation of information from the device by letting the device perform the calculations necessary to interpret the flow signal from its internal sensor based upon information in the selected calibration.

Table 5-2: Commonly Configured Parameters/Parameters

Parameter	EPATH	Applicable Units Table	Default
Flow Sensor Data Units	[0x02-1-4]	Appendix C: Table 9-2 Volumetric Flow Units Table	Percent
Flow Totalizer Data Units	[0x02-1-125]	Appendix C: Table 9-5 Volume Units Table	Liters
Flow Control Data Units	[0x03-1-4]	Appendix C: Table 9-2 Volumetric Flow Units Table	Percent
Temperature Data Units	[0x05-1-4]	Appendix C: Table 9-4 Temperature Units	deg C

Section 5 Configuration

Safe Mode

All products in the SLA Series product line employ an internal State Machine to govern the operational mode of the device. One operational mode is the Safe Mode (a.k.a. the Safe State). For MFC(s), Safe Mode stops the controller and forces the valve actuator to a defined state (see section Valve Safe Mode). By default, the valve actuator will be closed. The state of the actuator in Safe Mode can be configured in the Valve Actuator module, parameters [0x04-1-21] and [0x04-1-22].

The device will be in Safe Mode when any of the following conditions exist:

- If any Error Status bit is set [0x07-1-4]
- If no cyclic connection is active
- If the cyclic connection is closed or times out

Valve Safe Mode

The valve safe mode is the state the valve actuator will be in when the device is in Safe Mode. To configure the safe mode of the valve, use parameter 'Actuator Safe State' in the Valve Driver Module [0x04-1-21]. These states apply to both Normally Closed and Normally Open Valves.

Table 5-3: Safe State

Value	State
0	Closed (default)
1	Open
2	Hold
3	Use Safe Value

Process Gas Page Configuration

If the MFC/MFM contains multiple calibrations, the selection of a particular calibration can be configured in parameter 'Calibration Instance' of the Flow Meter Module [0x02-1- 35].

The value of this parameter is limited to the number of Flow Calibration Modules configured in the device. The minimum value is 1, which is also the default value.

Additionally, the calibration can be selected using through cyclic data by setting Cal_Instance field in Flow Meter module. A value of 0 in this field is ignored by the device. If the field is set to an invalid value, the process gas selection will not change and the 'Invalid Process Gas Page Selected' alarm status will be set.

Section 5 Configuration

Module I/O Data

The tables list the available modules for PROFINET SLA Series MFC/MFM. All modules have fixed slot assignments.

MFC

Table 5-4: MFC Modules

Name	Slot	Description
Device Management	0x01	Parameters that are general to the device such as supply voltage and configuration information
Flow Meter	0x02	Parameters related to flow measurement, flow related alarms/warnings, and flow diagnostics
Flow Controller	0x03	Parameter related to the MFC controller such as setpoint, control related alarms/warnings, and control overrides
Valve Driver	0x04	Parameters related to the valve actuator position and actuator related alarms/warnings
Temperature Meter	0x05	Parameters related to temperature measurement and temperature related alarms/warnings
Process Gas	0x06	Parameters related to Process Gas calibration pages
Status	0x07	Parameters related to status indications such as Alarms, Warnings, Errors and general device status

MFM

Table 5-5: MFM Modules

Name	Slot	Description
Device Management	0x01	Parameters that are general to the device such as supply voltage and configuration information
Flow Meter	0x02	Parameters related to flow measurement, flow related alarms/warnings, and flow diagnostics
Temperature Meter	0x05	Parameters related to temperature measurement and temperature related alarms/warnings
Process Gas	0x06	Parameters related to Process Gas calibration pages
Status	0x07	Parameters related to status indications such as Alarms, Warnings, Errors and general device status

Section 5 Configuration

Module: Device Management**Input Size: 4 Bytes / 2 Words**

Table 5-6: Device Management Module Inputs

Parameter	Slot	Data Type	Data Size	Description
Supply Voltage	1	REAL	4	The value of the supply voltage to the device

Module: Flow Meter**Input Size: 16 Bytes / 8 Words**

Table 5-7: Flow Meter Module Inputs

Parameter	Slot	Data Type	Data Size	Description
Flow	2	REAL	4	The measured value of the flow sensor (PV) in engineering units defined by Data Units parameter {2-1-4}. Default engineering units is percent
Total Flow Hours	2	DINT	4	Total hours of flow through the device
Flow Totalizer	2	REAL	4	Total flow through the device in engineering units defined by Flow Total Units parameter {2-1-125}. Default engineering units is Liters
Cust Flow Totalizer	2	REAL	4	Customer flow totalizer in engineering units defined by Flow Total Units parameter {2-1-125}. Default engineering units is Liters

Output Size: 8 Bytes / 4 Words

Table 5-8: Flow Meter Module Outputs

Parameter	Slot	Data Type	Data Size	Description
Cal Instance	2	REAL	4	Sets the active Calibration Gas Page used to report flow Valid Range of Values: 0 thru 6 A value of 0 is quietly ignored and will clear the Invalid Gas Page Alarm status To select instances 1 thru 6, Setpoint must be 0.0 Instance 1 thru 6 will be accepted if a gas page exists for that instance. If a gas page does not exist, the value will be rejected, and the Invalid Gas Page Alarm status will be raised. If page exists, the gas page will be selected, and the Invalid Gas Page alarm will be cleared if set.
Cust Flow Totalizer Control	2	DINT	4	Controls the behavior of Cust Flow Totalizer/ Valid Range of Values: 1 thru 3. All other values have no effect 1: Run 2: Stop 3: Reset

Section 5 Configuration

Module: Flow Controller**Input Size: 4 Bytes / 2 Words***Table 5-9: Flow Controller Module Inputs*

Parameter	Slot	Data Type	Data Size	Description
Ctrl Live Setpoint	1	REAL	4	The value of the supply voltage to the device

Output Size: 12 Bytes / 6 Words*Table 5-10: Flow Controller Module Outputs*

Parameter	Slot	Data Type	Data Size	Description
Flow	3	REAL	4	The command flow value (CV) sent to the flow controller in engineering units defined by Data Units parameter {3-1-4}. Default engineering units is percent
Total Flow Hours	3	DINT	4	Overrides the automatic control of the flow controller. Valid values are: 0: Automatic Control 1: Close Actuator 2: Open Actuator 129: Use Fixed Ctrl Value
Flow Totalizer	3	REAL	4	Sets the position of the valve actuator when Ctrl Override is set to 129: Use Fixed Ctrl Value. Engineering units is percent

Module: Flow Controller**Input Size: 4 Bytes / 2 Words***Table 5-11: Valve Driver Module Inputs*

Parameter	Slot	Data Type	Data Size	Description
Valve Position	4	REAL	4	The position of the actuator in engineering units of percent.

Output Size: 4 Bytes / 2 Words*Table 5-12: Valve Driver Module Outputs*

Parameter	Slot	Data Type	Data Size	Description
Valve Override	4	REAL	4	Overrides the flow controller

Section 5 Configuration

Module: Temperature Meter**Input Size: 4 Bytes / 2 Words***Table 5-13: Valve Driver Module Inputs*

Parameter	Slot	Data Type	Data Size	Description
Temperature	15	REAL	4	The temperature of the flow meter

Module: Process Gas**Input Size: 20 Bytes / 10 Words**

The values displayed in this module are the value from the selected (active) process gas page

Table 5-14: Process Gas Module Inputs

Parameter	Slot	Data Type	Data Size	Description
PG Full Scale	6	REAL	4	The process gas page full scale calibration value
PG FAT Date	6	DINT	4	Factory acceptance date for the process gas page. The value represents the number of days since 1972. Valid range is 0 to 65535
PG ID	6	DINT	4	The Gas Standard Number as defined by SEMI publication SEMI E52-0298, "Practice for Referencing Gases Used in Digital Mass Flow Controllers."
PG Data Units	6	DINT	4	The process gas page calibration engineering units
PG Flow Totalizer	6	REAL	4	The number of hours flow using this process gas page

Module: Status**Input Size: 16 Bytes / 4 Words**

See Section 'Status Module [0x07] for status bit definitions

Table 5-15: Process Gas Module Inputs

Parameter	Slot	Data Type	Data Size	Description
Active Errors	7	DWORD	4	The position of the actuator in engineering units of percent.
Active Alarms	7	DWORD	4	Active Alarms Status Bits
Active Warnings	7	DWORD	4	Active Warning Status Bits
Active Status		DWORD	4	Device Status Bits

Section 6 Detailed Configuration

Section 6: Detailed Configuration

Overview

This section is recommended for advanced users of PROFINET™ and Brooks Instrument MFC/ MFM products.

The following sections detail other parameters associated with modules that can be accessed using Read/Write record messages.

Device Manager Module [0x01]

Device Types: MFC and MFM

The Device Manager Module contains product information about the SLA Series MFC/MFM device such as serial number, model number, firmware revisions, etc. The module also captured device level operational parameters not specific to any other application module defined in the device.

Parameters

Table 6-1: Device Manager Parameters

Param ID	Name	Data Type	Access Rule	NV	Description	Notes
1	Device Type	SHORT STRING	Get	NV	Device model name	Max. 8 Characters "MFC" or "MFM"
3	Manufacturer's Name	SHORT STRING	Get	NV	The name of the manufacturer of the device.	Max. 20 characters 'Brooks Instrument'
4	Manufacturer's Model Number	SHORT STRING	Get	NV	The manufacturer specified model number for the device	Max. 20 characters
5	Software Revision Level	SHORT STRING	Get	NV	Revision level of the firm-ware in the device.	Note: 'Revision Levels' below
6	Hardware Revision Level	SHORT STRING	Get	NV	Revision level of the hard-ware in the device.	
7	Manufacturer's Serial Number	SHORT STRING	Get	NV	Serial number of device assigned by the manufacturer	Max. 30 Characters

Section 6 Detailed Configuration

Param ID	Name	Data Type	Access Rule	NV	Description	Notes
8	Device Configuration	SHORT STRING	Get	NV	Any additional manufacturer specific information about the device	Max. 50 characters 'N/A'
103	Main Board Boot-loader Version	SHORT STRING	Get	NV	Revision level of the Main Board Bootloader firmware	Max. 8 Characters. See Section Revision Level
104	Device Configuration ID	DINT	Get	NV	Configuration Level of the device assigned by the manufacturer	
147	Zero Button Disable	DINT	Set	NV	Disables the ability to zero the device using the external button	
190	Supply Voltage	REAL	Get	NV	Input supply voltage to the device in Volts	Volts
191	Supply Voltage Minimum Warning Limit	REAL	Set	NV	Minimum threshold, in Volts, to set the Supply Volts Low Warning bit	See Section Notes: Supply Voltage See Section Notes: Status
192	Supply Voltage Maximum Warning Limit	REAL	Set	NV	Maximum threshold, in volts, to set the Supply Volts High Warning bit	See Section Note: Supply Voltage See Section Note: Status
193	Supply Voltage Warning Settling Time	DINT	Set	NV	The amount of time, in milliseconds, the warning condition must exist before the warning bit is set	See Section Note: Supply Voltage See Section Note: Status
222	Power On Hours	REAL	Get	NV	Power on time totalizer	See Section Note: Count Up Timers
250	Communications Board Firmware Revision Level	SHORT STRING	Get	NV	Revision level of the communications board firmware	Max. 10 characters. See Section Revision Level
251	Communications Board Hardware Revision Level	SHORT STRING	Get	NV	Revision level of the communications board hardware	Max. 10 characters. See Section Revision Level
252	Communications Board Bootloader Revision Level	SHORT STRING	Get	NV	Revision level of the communications bootloader firmware	Max. 10 characters. See Section Revision Level

Section 6 Detailed Configuration

Note: Status

Status bits associated with this module are listed below. See section 7 for details on specific status and behavior.

- **[Active_Warnings]{184-1-5}, Bit 26:** Supply Voltage High
- **[Active_Warnings]{184-1-5}, Bit 27:** Supply Voltage Low

Note Revision Level

Parameters representing firmware revisions running in the device are comprised of the major and minor revision level, separated by a decimal point (for example, 1.04).

Note Supply Voltage

The Device Manager Module reports the input supply voltage to device. Warning status bits (See Status Module section) can be used to indicate high or low input voltage condition. Setting parameters 191 and 192 set the threshold values for setting the status flags. The statuses are self-clearing when the voltage returns within nominal range. Parameter 193 can be configured to delay the setting or clearing of the status to minimize spurious indications.

Count-Up Timers

Power On Hours [222] is a count-up timer that represents the total time, in hours, that the device has been powered on. This timer is not resettable.

Section 6 Detailed Configuration

Flow Meter Module [0x02]

Device Types: MFC and MFM

The Flow Meter Module is responsible for reporting flow sensor values. The Flow Meter Module in conjunction with the selected Flow Meter Module can linearize the sensor values and convert measurements into engineering data units.

Parameters

Table 6-2: Flow Meter Module Parameters

Param ID	Name	Data Type	Access Rule	NV	Description	Notes
4	Device Configuration	SHORT STRING	Get	NV	Any additional manufacturer specific information about the device	Max. 50 characters 'N/A'
6	Main Board Boot-loader Version	SHORT STRING	Get	NV	Revision level of the Main Board Bootloader firmware	Max. 8 Characters. See Section Revision Level
17	Device Configuration ID	DINT	Get	NV	Configuration Level of the device assigned by the manufacturer	
18	Zero Button Disable	DINT	Set	NV	Disables the ability to zero the device using the external button	
19	Supply Voltage	REAL	Get	NV	Input supply voltage to the device in Volts	Volts
20	Supply Voltage Minimum Warning Limit	REAL	Set	NV	Minimum threshold, in Volts, to set the Supply Volts Low Warning bit	See Section Notes: Supply Voltage See Section Notes: Status
21	Supply Voltage Maximum Warning Limit	REAL	Set	NV	Maximum threshold, in volts, to set the Supply Volts High Warning bit	See Section Note: Supply Voltage See Section Note: Status
22	Supply Voltage Warning Settling Time	DINT	Set	NV	The amount of time, in milliseconds, the warning condition must exist before the warning bit is set	See 'Note: Status' below Data Units set by
23	Power On Hours	REAL	Get	NV	The amount by which Flow [6] must recover past the Trip Point threshold ([21] and [22]) to clear the associated status condition	See Section Note: Count Up Timers

Section 6 Detailed Configuration

Param ID	Name	Data Type	Access Rule	NV	Description	Notes
24	Warning Settling Time	DINT	Set	NV	Determines the time that the Flow [6] value must exceed the Trip Point before the exception condition is generated	See 'Note: Status' below Time in milliseconds
35	Gas Calibration Module Instance	DINT	Set	NV	Configures which S-Gas Calibration Module instance is currently active for this module	See Note 'Gas Calibration Module Instance' below
96	Flow Hours	DINT	Get	NV	Total hours of flow through the device	
105	Zero Duration	DINT	Set	NV	The amount of time used by the device to perform a device zero operation	Time in milliseconds
112	Zero Enable	BOOL	Set	V	Starts a device sensor zero operation	Write '1' to this parameter starts a zero operation provided device status 'Zero Operation Inhibit' is not set See Section 7.1.6
125	Totalizer Units	DINT	Set	NV	The engineering units used to report the totalizer values in this module	See Note 'Data Units' and 'Totalizers' below
126	Flow Totalizer	REAL	Set	NV	Total gas flowed through the device	See Note 'Totalizers' below Data Units set by [125]
130	Custom Flow Totalizer	REAL	Set	NV	Total gas flowed through the device since the last commanded 'Reset' through Custom Flow Totalizer Control [131]	See Note 'Totalizers' below Data Units set by [125]
131	Custom Flow Totalizer Control	DINT	Set	V	Commands start, stop and reset of Custom Flow Totalizer	See Note 'Totalizers' below
140	Zero Recommend Time	DINT	Set	NV	Time limit since the last zero operations that will set the 'Zero Recommended' status	See 'Note: Status' below and Section 7.1.5 Time in seconds 0 = Disabled
141	Zero Tolerance Settle Time	DINT	Set	NV	The number of seconds after 0% setpoint that the device will wait before checking 'Zero Recommend' status	See 'Note: Status' below and Section 7.1.5 MFC Only

Section 6 Detailed Configuration

Param ID	Name	Data Type	Access Rule	NV	Description	Notes
142	Zero Tolerance Band	REAL	Set	NV	The tolerance band for which the 'Zero Recommended' status will be set if when setpoint = 0%	See 'Note: Status' below and Section 7.1.5 0 = Disabled MFC Only
143	Zero Success Band	REAL	Set	NV	The error band for which the 'Bad Zero Warning' status will be set after completion of a zero operation and the resulting zero exceeds this band	See 'Note: Status' below and Section 7.2.5
144	Zero Minimum Drift Time	DINT	Get	NV	The minimum time limit between two successful zero operations that must occur before an excessive zero drift diagnostic will be run	See 'Note: Status' below and Section 7.2.5
145	Excessive Zero Drift Multiplier	REAL	Set	NV	A span adjustment to adjust/expand the Expected Drift rate	See 'Note: Status' below and Section 7.2.4
146	Excessive Zero Drift Offset	REAL	Set	V	An offset adjustment to adjust/expand the Expected Drift rate	See 'Note: Status' below and Section 7.2.4
148	Total Drift	REAL	Get	NV	The total zero drift since flowing with current gas page	See 'Note: Status' below and Section 7.2.4
149	Zero History Table	STRUCT of:	Set	NV	Data collected on the last 128 zero operations	To retrieve data from the Zero History Table see Service Code 0x32 below
	Calibration Instance	UDINT			The Calibration Instance at the time of the zero operation	
	Zero Drift	REAL			The Zero Drift prior to commencing the zero operation	
	Temperature	REAL			Total power on hours at the time of the zero operation	
	Power On Hours	UDINT			Time limit since the last zero operations that will set the 'Zero Recommended' status	
222	No Flow Limit	REAL	Set	NV	The percentage of setpoint by which if 'Flow' does not exceed will raise an 'Active_Alarms_No_Flow' status is raised	See 'Note: Status' below and Section 7.3.3 Units in percent MFC Only

Section 6 Detailed Configuration

Param ID	Name	Data Type	Access Rule	NV	Description	Notes
223	No Flow Settling Time	DINT	Set	NV	The time in which a No Flow condition must exist before a status is raised	See 'Note: Status' below and Section 7.3.3 Time in milliseconds MFC Only
224	Choked Flow Limit	REAL	Set	NV	The percentage of set-point by which if 'Flow' does not exceed will raise an 'ActiveWarnings_Choked_Flow' or 'Active_Alarms_Choked_Flow' status is raised	See 'Note: Status' below and Section 7.2.3 and 7.3.3 Units in percent MFC Only
225	Choked Flow Settling Time	DINT	Set	NV	The time in which a choke flow condition must exist before a status is raised	See 'Note: Status' below and Section 7.2.3 and 7.3.3 Time in milliseconds MFC Only
226	Overhaul-Due	DINT	Set	NV	The time remaining in hours until device requires service. When this timer reaches 0, 'Overhaul Due Warning' status shall be set	See Note 'Timers' below
227	Calibration Due	DINT	Set	V	The time remaining in hours until the device needs to be recalibrated. When this timer reaches 0, 'Calibration Due Warning' status shall be set	See Note 'Timers' below
228	Backstream Flow Limit	REAL	Set	NV	The threshold by which reverse flow must exceed to raise a backstream error status	See 'Note: Status' below and Section 7.4.1 Units in percent
229	Backstream Time Limit	DINT	Set	NV	The time in which a backstreaming flow condition must exist before a status is raised.	See 'Note: Status' below and Section 7.4.1 Time in milliseconds
230	Flow Totalizer Overflow Threshold	REAL	Set	NV	The threshold by which Flow Totalizer [126] must exceed before a 'Totalizer Overflow' status is raised	See 'Note: Status' below and Section 7.2.12

Section 6 Detailed Configuration

Note: Status

The value of this parameter is limited to the values specified in the Volumetric Flow Units Table in Appendix C - Data Units.

Note: Status

Status bits associated with this module are listed below. See section 7 for details on specific status and behavior.

- **[Active_Errors]{184-1-3}, Bit 2:** Back Streaming Error
- **[Active_Alarms]{184-1-4}, Bit 0:** Low Flow Alarm
- **[Active_Alarms]{184-1-4}, Bit 1:** High Flow Alarm
- **[Active_Alarms]{184-1-4}, Bit 2:** No Flow Alarm
- **[Active_Alarms]{184-1-4}, Bit 3:** Choked Flow Alarm
- **[Active_Alarms]{184-1-4}, Bit 15:** Invalid Process Gas Page Selected
- **[Active_Warnings]{184-1-5}, Bit 0:** Low Flow Warning
- **[Active_Warnings]{184-1-5}, Bit 1:** High Flow Warning
- **[Active_Warnings]{184-1-5}, Bit 3:** Choked Flow Warning
- **[Active_Warnings]{184-1-5}, Bit 4:** Excessive Zero Drift Warning
- **[Active_Warnings]{184-1-5}, Bit 5:** Bad Zero Warning
- **[Active_Warnings]{184-1-5}, Bit 17:** Calibration Due
- **[Active_Warnings]{184-1-5}, Bit 18:** Totalizer Overflow
- **[Active_Warnings]{184-1-5}, Bit 19:** Overhaul Due

Note: Gas Calibration Module Instance

The value of this parameter is limited to the number of Process Gas Module instances configured in the device. The minimum value is 1, which is also the default value.

Note: Totalizers

There are two totalizers: Flow Totalizer [126] and Custom Flow Totalizer [130]. The behavior of each totalizer is described in the following sections. The units of measure for both totalizers are set using Totalizer Units [125].

Flow Totalizer

Flow Totalizer [126] is a count-up flow totalizer. The parameter can be set to any value. If this totalizer value exceeds Totalizer Overflow Threshold [230], status Active_Warnings_Totalizer_Overflow {184-1-5} will be set. Setting this totalizer value below the overflow threshold will clear the status.

Section 6 Detailed Configuration

Custom Flow Totalizer

Custom Flow Totalizer [130] is a count-up flow totalizer. This totalizer value is controlled by Custom Flow Totalizer Control [131]. Options for controlling the totalizer are Run (1), Stop (2), and Reset (3). Reading Custom Flow Totalizer Control [131] will return the current operational state of the timer: Run (1) or Stop (2). When the Reset (3) command is written to Custom Flow Totalizer Control [131], the totalizer will reset to zero, and then return to its operational state prior to writing the reset command.

Countdown Timers

Overhaul Due [226] and Calibration Due [227] are countdown timers. These timers can be utilized to raise preventative maintenance and calibration events. Counting down commences when the device is flowing gas. When the counters reach zero, their respective status' [Active_Alarms_Overhaul_Due] [184-1-5], and [Active_Alarms_Calibration_Due] [184-1-5] will be set. Writing a non-zero value to these timers will clear their respective status'. These timers can be written to at any time.

Section 6 Detailed Configuration

Valve Driver Module [0x04]

Device Types: MFC

The Valve Driver module is responsible for management of the actuator device controlling the process.

Parameters

Table 6-3: Valve Driver Module Parameters

Param ID	Name	Data Type	Access Rule	NV	Description	Notes
5	Override	DINT	Set	V	Specifies a direct override of the physical actuator	See Note 'Override' below
6	Valve Position	REAL	Get	V	The value of the analog output signal used to drive the physical actuator	See Note 'Valve' below. Units in Percent
18	Warning Trip Point High	REAL	Set	NV	Determines the Value [6] above which a warning condition will occur	See Note 'Status' below Units in Percent
19	Warning Trip Point Low	REAL	Set	NV	Determines the Value [6] below which a warning condition will occur	See Note 'Status' below Units in Percent
20	Warning Hysteresis	REAL	Set	NV	Determines the Value [6] that must recover from a warning condition to clear the warning status	See Note 'Status' below
21	Safe State	DINT	Set	NV	Specifies the behavior for the physical actuator in an Operational State other than Executing State	See Note 'Safe State' below
22	Safe Value	REAL	Set	NV	The analog output signal value that is indicated by Value [6] if the Safe State[21] is configured to 'Use Safe Value'	Default = 0%
143	Control Warning Threshold	REAL	Set	NV	The threshold above which the computed standard deviation of Valve Position [6] exceeds will raise the Valve Control Warning status. A value of 0.0 disables this diagnostic	See Note 'Valve Control Warning' below Units in Percent
144	Control Warning Settling Time	DINT	Set	Set	The time that standard deviation of 'Valve_Position' must exceed the Trip Point threshold before the Status Condition is raised. This value also sets the time that standard deviation of 'Valve_Position' has recovered from the Trip Point threshold before the associated status condition is cleared	See Note 'Valve Control Warning' below Units in milliseconds

Section 6 Detailed Configuration

Note: Override

The following table outlines the valid actuator override types.

Table 6-4: Override

Value	State	Description
0	Normal	Actuator is under normal operational control
1	Closed	Actuator is driven fully closed
2	Open	Actuator is driven fully open
3	Hold	Actuator is held to last updated analog output signal prior to assertion of override
4	Safe State	Actuator is driven to the condition specified by the Safe State [21] parameter

Note: Valve

To interpret the value of this parameter, it is important to understand the following terms:

Operational Range:

This is the range that is reported by Value [6]. The operational range of the actuator is full range that the actuator can be driven to move. This corresponds to Value [6] values of 0 to 100%.

Nominal Control Range:

The nominal control range is a set of values that the actuator is driven to that maps directly between no flow and full-scale flow. This set of values is a sub-range within the large operational range of the actuator.

Example, the nominal control range for a 0 to 100 SCCM device flowing nitrogen could be as follows:

at 0 SCCM Actuator = 20%

at 100 SCCM, Actuator = 30%

Under normal operational control (no override), the actuator generally operates in the nominal control range. The upper end of the control range is not an absolute limit under normal control. The controller will drive the actuator to whatever value is necessary to control flow. For example, if a restriction occurred upstream of the device resulting in reduced supply to the device, the controller will drive the actuator beyond the nominal control range to maintain control.

Section 6 Detailed Configuration

Status

Status bits associated with this module are listed below. For details, see Section 7.

- **[Active_Warnings]{184-1-5}, Bit 8:** Valve High Warning
- **[Active_Warnings]{184-1-5}, Bit 9:** Valve Low Warning
- **[Active_Warnings]{184-1-5}, Bit 10:** Valve Control Warning

Valve Control Warning

Valve control warning is based upon a statistical computation by computing a rolling standard deviation on the valve position. This diagnostic is disabled if the threshold value is set to 0.

Safe State

The following table outlines valid values for this parameter. This table applies for normally closed and normally open valves.

Table 6-5: Safe State

Value	State	Description
0	Closed	The actuator will be driven closed (0%)
1	Open	The actuator will be driven open (100%)
2	Hold Last Value	The actuator will be driven to the last updated value of the analog output just prior to the entering of the safe state.
3	Use Safe Value	The actuator will be driven to the value configured in Safe Value [22]

Section 6 Detailed Configuration

Flow Controller Module [0x03]

Device Types: MFC

The Flow Controller module is responsible for closing the loop between the measured process variable (via the Flow Meter Module) and the control variable (via the Valve Drive Module).

Parameters

Table 6-6: Flow Controller Module Parameters

Param ID	Name	Data Type	Access Rule	NV	Description	Notes
4	Data Units	ENGUNITS	Set	NV	Defines the Engineering Units context of Setpoint [6] and other parameters in this module	See 'Note: Data Units' below
5	Control Override	DINT	Set	V	Overrides the automatic control of the flow controller	See 'Note: Control Override'
6	Setpoint	REAL	Set	V	The sensor value that the device will maintain a steady state condition	Units set by [4]
15	Warning Settling Time	DINT	Set	NV	Time allowed for the control-loop to settle to within the error band	See 'Note: Status' below Time in milliseconds
16	Warning Error Band	DINT	Set	NV	The maximum deviation band by which Setpoint must equal the Process Variable before a status is indicated	See 'Note: Status' below Units set by [4]
19	Constant Time Ramp Rate	UDINT	Set	NV	The amount of time the controller will take to "ramp" flow from its current value to its final value as commanded in Setpoint [6]	Default = 0 [disabled] Time in milliseconds
159	Fixed Control Value	REAL	Set	V	Sets the valve actuator position when Control Override [5] is set to 'Fixed'	Units are %
194	Setpoint Limit	DINT	Set	NV	The maximum value for setpoint. If setpoint exceeds this value, the behavior of the controller is defined by Setpoint Limit Action [201]	Units set by [4]
201	Setpoint Limit Action	DINT	Set	NV	Sets the behavior of the controller when Setpoint [6] > Setpoint Limit [194]	See Note: Setpoint Limit Action

Section 6 Detailed Configuration

Param ID	Name	Data Type	Access Rule	NV	Description	Notes
202	Live Setpoint	REAL	Get	V	The actual setpoint to which the process variable Flow will be controlled	See section 7.2.10 for more information on Setpoint Limiting

Note: Data Units

The value of this parameter is limited to the values specified in the Volumetric Flow Units Table and Mass Flow Units table in Appendix C - Data Units.

Note: Status

Status bits associated with this module are listed below. For details, see Section 7.

- **[Active_Warnings]{184-1-5}, Bit 11:** Setpoint Deviation
- **[Active_Warnings]{184-1-5}, Bit 13:** Setpoint Overrange
- **[Active_Warnings]{184-1-5}, Bit 14:** Setpoint Limited

Note: Setpoint Limited Action

See section 7.2.10 for more information on Setpoint Limiting

Table 6-7: Setpoint Limiting Actions

Value	Description
0	Setpoint Limiting disabled
1	Raise 'Setpoint Over range' warning status, but do not actively limit the setpoint
2	Raise 'Setpoint Limited' status and actively limit the setpoint to Setpoint Limit [194]

Note: Control Override

Table 6-8: Setpoint Limiting Actions

Value	Description
0	Automatic Control
1	Control Override – Actuator Off
2	Control Override – Actuator Open 100%
129	Control Override – Set Actuator Position to the value in parameter 'Fixed Control Value' [159]

Section 6 Detailed Configuration

Process Gas Module [0x06]

Device Types: MFC and MFM

The Process Gas module defines characteristics associated with linearization/compensation of the gas flow sensor. There are 6 subslots in this module defined for process gas pages.

Parameters

Table 6-9: Process Gas Module Parameters

Param ID	Name	Data Type	Access Rule	NV	Description	Notes
37	Device Configuration	REAL	Get	NV	The gas temperature, in Celsius, under which this calibration was performed	
38	Reference Pressure	REAL	Get	NV	The gas pressure, in Pa, under which this calibration was performed	
40	Gas Standard Number	DINT	Get	NV	The gas type number assigned to this gas	See Note: 'Gas Standard Number' below Default = 0, no gas type specified
42	Calibration Data Units	DINT	Get	NV	The engineering units of measure assigned to this gas	See Appendix C for units codes
45	Configured Range	REAL	Get	NV	The maximum calibrated flow value	
47	Total Flow Hours	REAL	Set	NV	The total number of hours flow through the device with this instance of the process gas page selected	
200	FAT Date	DATE	Set	NV	The factory acceptance date for this gas calibration	Number of days since 1972 0 = 1/1/1972

Note: Gas Standard Number

The Gas Standard Number as defined by SEMI publication SEMI E52-0298, "Practice for Referencing Gases Used in Digital Mass Flow Controllers."

Section 6 Detailed Configuration

Temperature Meter Module [0x05]

Device Type(s): MFC and MFM

The Temperature Meter module measures the temperature of the process gas.

Parameters

Table 6-10: Temperature Meter Module Parameters

Param ID	Name	Data Type	Access Rule	NV	Description	Notes
4	Temperature Units	DINT	Set	NV	Sets the engineering units of measure of Temperature [6] and related parameters in this class	See Appendix C for unit codes
6	Temperature	REAL	Get	V	Temperature sensor value	Units set by [4]
21	High Temperature Warning Trip Point	REAL	Set	NV	Sets the threshold above which a High Temperature status will occur	See 'Note: Status' below Units set by [4]
22	Low Temperature Warning Trip Point	REAL	Set	NV	Sets the threshold below which a High Temperature status will occur	See 'Note: Status' below Units set by [4]
24	Warning Trip Point Settling Time	REAL	Set	NV	Sets the time that Temperature [6] must exceed the Trip Point thresholds before the Status Condition is raised. This value also sets the time that 'Temperature' has recovered from the Trip Point threshold before the associated status condition is cleared	See 'Note: Status' below Time in milliseconds

Status

Status bits associated with this module are listed below. For details, see section 7.

- **[Active_Alarms]{184-1-4}, Bit 24:** Temperature Sensor Fail
- **[Active_Warnings]{184-1-5}, Bit 24:** High Temperature
- **[Active_Warnings]{184-1-5}, Bit 25:** Low Temperature

Section 6 Detailed Configuration

Status Module [0x07]

The Status Module contains all the status bits that can be indicated by the device. Details of how each status indication functions and their associated parameters for configure the status function can be reference in Section 7

Parameters

Table 6-11: Status Module Parameters

Param ID	Name	Data Type	Access Rule	NV	Description	Notes
3	Active Errors	DWORD	Get	NV	Active Error Status Bits	See Note 'Active Errors'
4	Active Alarms	DWORD	Get	V	Active Alarms Status Bits	See Note 'Active Alarms'
5	Active Warnings	DWORD	Get	NV	Active Warning Status Bits	See Note 'Active Warnings'
6	Device Status	DWORD	Get	NV	Device Status Bits	See Note 'Device Status'
8	Alarms Mask	DWORD	Get	NV	Active Alarms Mask Bits	See Note 'Mask Bits'
9	Warnings Mask	DWORD	Get	NV	Active Warnings Mask Bits	See Note 'Mask Bits'

Note: Active Errors

Table 6-12: Active Error Bit Definitions

Bit(s)	Description
0-1	Reserved
2	Back Streaming Error
3-17	Reserved
18	Internal Communications Error
19-22	Reserved
23	NV Memory Fail
24-31	Reserved

Note: Active Alarms

Table 6-13: Active Alarms Bit Definitions

Bit(s)	Description
0	Low Flow Alarm
1	No Flow Alarm
2	No Flow Alarm
3	Choked Flow Alarm

Section 6 Detailed Configuration

Bit(s)	Description
4-14	Reserved
15	Invalid Process Gas Page Selected
16-22	Reserved
23	Using Backup NV Memory
24	Temperature Sensor Fail
25-31	Reserved

Note: Active Warnings*Table 6-14: Active Warnings Bit Definitions*

Bit(s)	Description
0	Low Flow Warning
1	High Flow Warning
2	Reserved
3	Choked Flow Warning
4	Excessive Zero Drift Warning
5	Bad Zero Warning
6-7	Reserved
8	Valve High Warning
9	Valve Low Warning
10	Valve Control Warning
11	Setpoint Deviation
12	Reserved
13	Setpoint Overrange
14	Setpoint Limited
15-16	Reserved
17	Calibration Due
18	Totalizer Overflow
19	Overhaul Due
20-23	Reserved
24	High Temperature
25	Low Temperature
26	Supply Volts High
27	Supply Volts Low
28-31	Reserved

Section 6 Detailed Configuration

Note: Device Status*Table 6-15: Device Status Bit Definitions*

Bit(s)	Description
0	Device Is Executing
1	Flow Reading Valid
2	Temperature Reading Valid
3	Device Is Zeroing
4	Zero Recommended
5	Zero Operation Inhibit
6-7	Reserved
8	Device Error
9	Device Alarm
10	Device Warning
11-31	Reserved

Note: Mask Bits

Active Alarms [4] and Active Warnings [5] can be masked by setting the corresponding bits in the mask parameters Alarms Mask [8] and Warnings [9]

Section 7 Status

Section 7: Status

Device Status {7-1-6}

There are four levels of status: Errors, Alarms, Warnings, and Device Status in decreasing order of severity. The corresponding tag names for the status parameters are:

- **[Active_Errors] {7-1-3}**
- **[Active_Alarms] {7-1-4},**
- **[Active_Warnings] {7-1-5},**
- **[Device_Status] {7-1-6}**

Each status word is an enumerated bitfield of type DWORD. These status bits are in the Status Class (Class ID 7) and are mapped to Produce Assemblies 201, 203.

[Active_Alarms] {7-1-4} and **[Active_Warnings] {7-1-5}** can be masked by setting the corresponding mask parameters **[Alarms_Mask] {7-1-8}** and **[Warnings_Mask] {7-1-9}**. A value of 0 for any mask bit blocks the corresponding alarm or warning bit from being indicated. A value of 1 for any mask bit will allow the alarm or warning bit to be indicated.

[Active_Errors] {7-1-3} and **[Device_Status] {7-1-6}** cannot be masked. **If any bit in [Active_Errors] {7-1-3} is set, it will force the flow controller into the Safe State.** The device will require a reset to return to normal operation. A reset of the device can be achieved through a power cycle or by sending the Reset service (Service ID 5) to the Identity Class (Class ID 0x01).

Bit 0: Device is Executing [Device_Status_Dev_Exec]

This status indicates the current execution state of the device

Bit Value	Description
1	The device is Executing and controlling to setpoint
0	The device is in the Safe State

The state of this status bit is dependent on **[Active_Errors]{7-1-3}** (see section ‘Safe Mode’) and the existence of a Class 1 connection.

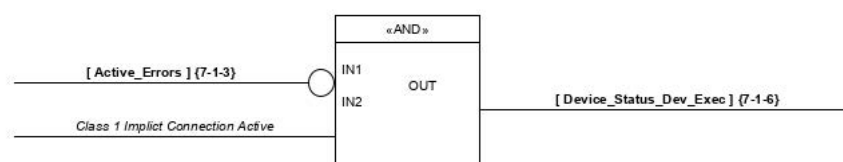

Section 7 Status

Bit 1: Flow Reading Valid [Device_Status_Flow_Valid]

This status indicates the quality of the flow sensor reading.

Bit Value	Description
1	The Flow Sensor operating nominally, and flow sensor readings are within normal range
0	Flow sensor reading is out of range and/or not operating nominally

NOTE: Sensor.Underrange and Sensor.Ovrange are internal variables

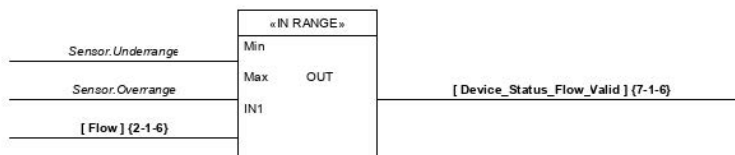

Bit 2: Temperature Reading Valid [Device_Status_Temp_Valid]

This status indicates the quality of the temperature sensor reading.

Bit Value	Description
1	The temperature sensor operating nominally, and temperature sensor readings are within normal range
0	Temperature sensor reading is out of range and/or not operating nominally

NOTE: Sensor.Underrange and Sensor.Ovrange are internal variables

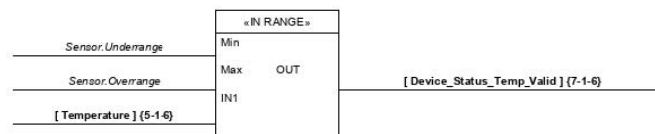

Bit 3: Device Is Zeroing [Device_Status_Dev_Zeroing]

This status indicated the current state a sensor zero operation.

Bit Value	Description
1	The device is currently executing a Sensor Zero operation
0	Sensor Zero operation is complete

Bit 4: Zero Recommended [Device_Status_Zero_Recommend]

This status indicates that the device should be zeroed (Sensor Zero operation is recommended). This status will be set when either of the following conditions is met:

Section 7 Status

Condition 1: Zero Warn Time Expired

Power on time since the last Successful Zero Operation > **[Zero_Recommend_Time {2-1-140}]**.

A Successful Zero Operation is defined as a completed Zero Operation that does not result in **setting [Device_Warn_Bad_Zero] {7-1-5} or [Device_Warn_Zero_Drift] {7-1-5}** warning statuses.

This diagnostic is disabled when **[Zero_Recommend_Time] {2-1-140} = 0**.

Condition 2: Zero Out of Tolerance

If **[Ctrl_Setpoint {158-1-6}] = 0** for > **[Zero_Tolerance_Settle_Time] {2-1-141}**

AND

Abs (**[Flow] {2-1-6}**) > 0.5 * **[Zero_Tolerance_Band] {2-1-142}**.

This diagnostic is disabled when **[Zero_Tolerance_Band] {2-1-142} = 0**.

Bit Value	Description
1	When one of the two above conditions have been met
0	A successful Zero Operation has been completed

Section 7 Status

Bit 5: Zero Operation Inhibit [Device_Status_Zero_Op_Inhibit]

This status indicates that the device cannot perform a zero operation. A sensor zero operation will be inhibited when **any** of the following conditions are present:

- **[Ctrl_Setpoint] {3-1-6}** is not zero
- **[Valve_Override] {4-1-5}** is not set to 'Normal' AND not set to 'Closed'
- The device is in the Safe State AND **[Valve_Safe_State] {4-1-21}** is not set to 'Closed'
- Any Alarm is Active **[Active_Alarms] {7-1-4}**
- Any Error is Active **[Active_Errors] {7-1-3}**

Bit Value	Description
1	Device Zero Operations are inhibited
0	Device Zero operations can be performed

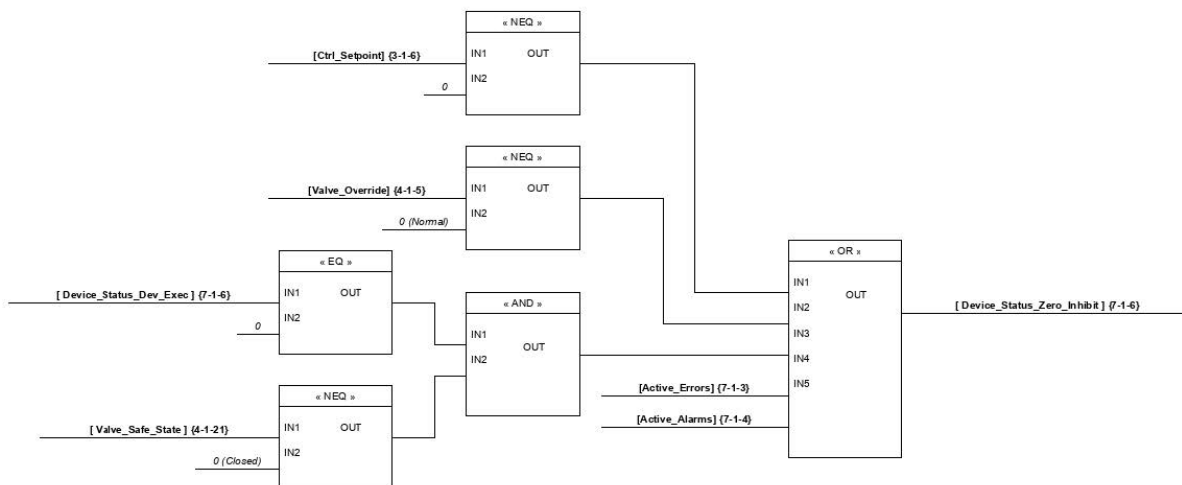

Bit 6: Valve Override [Device_Status_Valve_Override]

This status indicates the **[Valve_Override] {4-1-5}** is engaged

Bit Value	Description
1	Valve Override is Active (i.e. Off, Purge)
0	Valve Override is Normal

Section 7 Status

Bit 7: Control Override [Device_Status_Ctrl_Override]

This status indicates if any [Ctrl_Override] {3-1-5} is engaged

Bit Value	Description
1	Control Override is Active (i.e. Off, Purge, Fixed)
0	Control Override is Normal

Bit 8: Device Error [Device_Status_Dev_Error]

This status indicates if any [Active_Error] {7-1-3} are present

Bit Value	Description
1	One or more Errors are present
0	No Errors are present

Bit 9: Device Alarm [Device_Status_Dev_Alarm]

This status indicates if any [Active_Alarm] {7-1-4} are present

Bit Value	Description
1	One or more Errors are present
0	No Errors are present

Bit 10: Device Warning [Device_Status_Dev_Warning]

This status indicates if any [Active_Warnings] {7-1-5} are present

Bit Value	Description
1	One or more Warnings are present
0	No Warnings are present

Section 7 Status

Bit 11: Zero Button Disabled [Device_Status_Zero_Btn_Disabled]

This status indicates if any [Zero_Btn_Disable] {1-1-147} is set

Bit Value	Description
1	The zero button is disabled
0	The zero button is enabled

Bit 12: Control Ramping [Device_Status_Ctrl_Ramping]

This status indicates that the controller is ramping to the new commanded setpoint. This status becomes enabled when [Ramp_Time] {3-1-19} is set to a value other than 0

Bit Value	Description
1	The controller is ramping to the new commanded setpoint
0	The controller has reached the new commanded setpoint

Section 7 Status

Warnings {7-1-5}**Bit 0: Low Flow Warning [Active_Warnings_Low_Flow]**

The status indicates a low flow warning condition exists.

This status is *disabled* when [Device_Status_Flow_Valid] {7-1-6} = 0

See Diagram in section Typical Status High/Low Processing for typical behavior of this status.

Bit Value	Description
1	$[\text{Flow}] \{2-1-6\} < [\text{Flow_Warn_TP_Low}] \{2-1-22\}$ <p style="text-align: center;">FOR</p> $\text{Time Period} > [\text{Flow_Warn_Settling_Time}] \{2-1-24\}$
0	$[\text{Flow}] \{2-1-6\} > ([\text{Flow_Warn_TP_Low}] \{2-1-22\} + [\text{Flow_Warn_Hyst}] \{2-1-23\})$ <p style="text-align: center;">FOR</p> $\text{Time Period} > [\text{Flow_Warn_Settling_Time}] \{2-1-24\}$

Bit 1: High Flow Warning [Active_Warnings_High_Flow]

This status indicates a high flow warning status condition.

This status is *disabled* when [Device_Status_Flow_Valid] {7-1-6} = 0

See Diagram in section Typical Status High/Low Processing for typical behavior of this status.

Bit Value	Description
1	$[\text{Flow}] \{2-1-6\} > [\text{Flow_Warn_TP_High}] \{2-1-21\}$ <p style="text-align: center;">FOR</p> $\text{Time Period} > [\text{Flow_Warn_Settling_Time}] \{2-1-24\}$
0	$[\text{Flow}] \{2-1-6\} < ([\text{Flow_Warn_TP_High}] \{2-1-21\} - [\text{Flow_Warn_Hyst}] \{2-1-23\})$ <p style="text-align: center;">FOR</p> $\text{Time Period} > [\text{Flow_Warn_Settling_Time}] \{2-1-24\}$

Section 7 Status

Bit 3: Choked Flow Warning [Active_Warnings_Choked_Flow]

This status indicates a choked flow alarm is imminent.

This status is **disabled** when **any** of the following conditions exist:

- [Device_Status_Flow_Valid] {7-1-6} = 0
- [Active_Alarms_Choked_Flow_Alarm] {7-1-4} = 1
- [Ctrl_Setpoint] {3-1-6} = 0.0
- [Valve_Override] {4-1-5} = 1 (Off)

Bit Value	Description
1	$[\text{Flow}] \{2-1-6\} < ([\text{Choked_Flow_Lim}] \{2-1-224\} * [\text{Ctrl_Setpoint}] \{3-1-6\}) \text{ AND}$ $[\text{Valve_Position}] \{4-1-6\} > [70\% * \text{Max Valve Position}]$ <p style="text-align: center;">FOR</p> $\text{Time Period} > (30\% * [\text{Choked_Flow_Settling_Time}] \{2-1-225\})$
0	$[\text{Valve_Position}] \{4-1-6\} < [70\% * \text{Max Valve Position}]$ <p style="text-align: center;">OR</p> $[\text{Flow}] \{2-1-6\} > ([\text{Choked_Flow_Lim}] \{2-1-224\} * [\text{Ctrl_Setpoint}] \{3-1-6\})$

This warning status is a function of Setpoint and Settling Time whereby the trip point is a percentage of the current setpoint for 10% of the settling time.

Example: If [Choked_Flow_Limit] = 30%, [Choked_Flow_Settling_Time] = 10 seconds, and the current setpoint [Ctrl_Setpoint] = 80%, then the status will be raised when [Flow] < (30% * 80%) or 24% for (30% * 10 seconds) or 3 seconds.

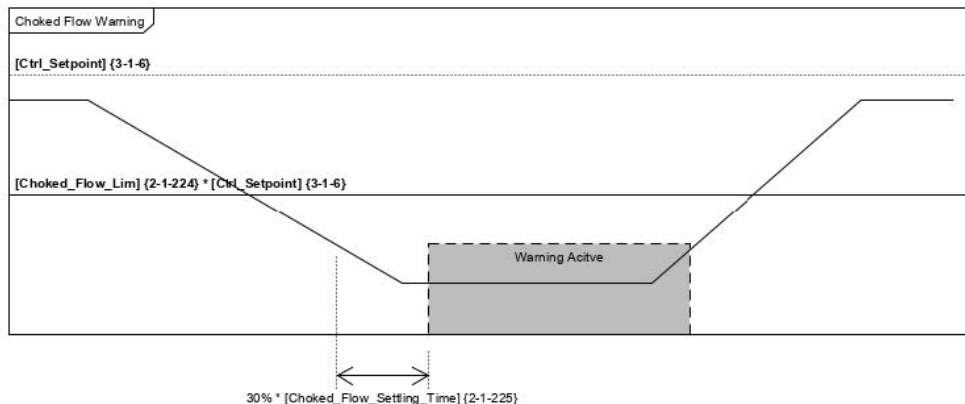

Section 7 Status

Bit 4: Excessive Zero Drift Warning [Active_Warnings_Zero_Drift]

This diagnostic indicates an excessive shift in zero since the last Zero Operation.

This diagnostic is run when [Ctrl_Setpont] {3-1-6} = 0 for [Zero_Warn_Settle_Time] {2-1-141}.

This diagnostic is *disabled* when [Zero_Min_Drift_Time] {2-1-144} = 0

Bit Value	Description
1	<p>The previous Zero Operation was successful</p> <p>AND</p> <p>Time since Last Zero Operation > [Zero_Min_Drift_Time] {2-1-144}</p> <p>AND</p> <p>The change in [Flow] {2-1-6} during the Zero Operation is: (0.2%FS/Year * [Excess_Drift_Mult] {2-1-145} + [Excess_Drift_Add] {2-1-146})</p>
0	<p>The selected calibration gas page is changed</p> <p>OR</p> <p>[Zero_Min_Drift_Time] {2-1-144} = 0</p>

This diagnostic is detecting a drift in zero since the last time the device was zeroed. This is predicated upon two conditions:

- 1) the previous zero operation was successful and,
- 2) a sufficient amount of time has transpired since the last zero operation as defined by [Zero_Min_Drift_Time] {2-1-144}.

Section 7 Status

Bit 5: Bad Zero Warning [Active_Warnings_Bad_Zero]

This diagnostic indicates that the last Zero Operation was not successful.

This diagnostic is *disabled* when [Zero_Success_Band] {2-1-143} = 0

Bit Value	Description
1	Zero Operation is Complete AND [Ctrl_Setpoint] {3-1-6} = 0 AND [Flow] {2-1-6} > [Zero_Success_Band] {2-1-143}
0	Zero Operation is Started OR [Zero_Success_Band] {2-1-143} = 0

This diagnostic is performing a qualitative assessment on the result of the current zero operation based upon the flow signal after the zero. For this diagnostic to be as accurate as possible, a good process for zeroing the device should be in place and followed.

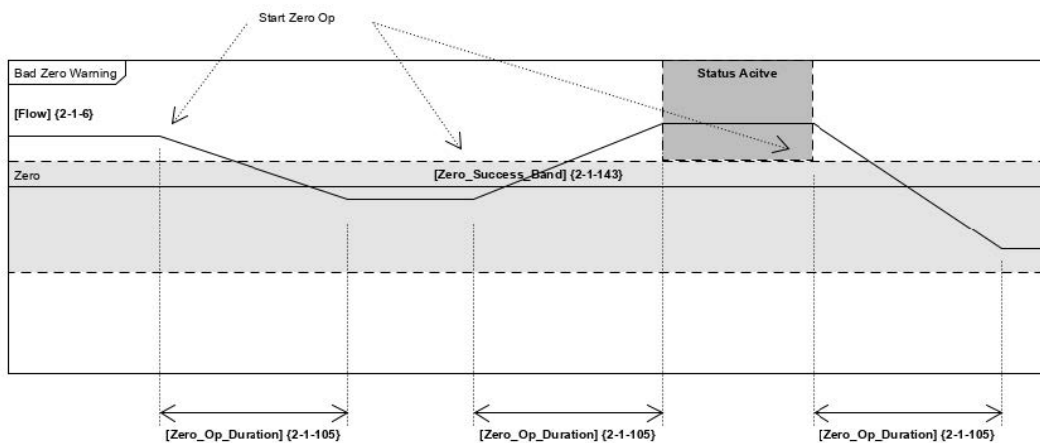

Section 7 Status

Bit 8: Valve High Warning [Active_Warnings_Valve_High]

The status indicates the valve position has exceeded a high position threshold.

See Diagram in section Typical Status High/Low Processing for typical behavior of this status.

Bit Value	Description
1	$[\text{Valve_Position}] \{4-1-6\} > [\text{Valve_Warn_TP_High}] \{4-1-18\}$
0	$[\text{Valve_Position}] \{4-1-6\} < ([\text{Valve_Warn_TP_High}] \{4-1-18\} + [\text{Valve_Warn_Hyst}] \{4-1-20\})$

Bit 9: Valve Low Warning [Active_Warnings_Valve_Low]

The status indicates the valve position has exceeded a low position threshold.

See Diagram in section Typical Status High/Low Processing for typical behavior of this status.

Bit Value	Description
1	$[\text{Valve_Position}] \{4-1-6\} < [\text{Valve_Warn_TP_Low}] \{4-1-19\}$
0	$\text{Valve_Position} \{4-1-6\} > ([\text{Valve_Warn_TP_Low}] \{4-1-19\} + [\text{Valve_Warn_Hyst}] \{4-1-20\})$

Bit 10: Valve Control Warning [Active_Warnings_Valve_Ctrl]

The Valve Control Warning diagnostic computes a rolling standard deviation of valve position and compares it to the threshold value set in parameter **[Valve_Ctrl_Warn_Limit] {4-1-143}**. This diagnostic is disabled when **[Valve_Ctrl_Warn_Limit] {4-1-143} = 0**.

See Diagram in section Typical Status High/Low Processing for typical behavior of this status.

Bit Value	Description
1	$\text{STDDEV}([\text{Valve_Position}] \{4-1-6\}) > [\text{Valve_Ctrl_Warn_Limit}] \{4-1-143\}$ For Time Period $> [\text{Valve_Ctrl_Warn_Settling_Time}] \{4-1-144\}$
0	$\text{STDDEV}([\text{Valve_Position}] \{4-1-6\}) \leq [\text{Valve_Ctrl_Warn_Limit}] \{4-1-143\}$ For Time Period $> [\text{Valve_Ctrl_Warn_Settling_Time}] \{4-1-144\}$

Section 7 Status

Bit 11: Setpoint Deviation [Active_Warnings_SP_Deviation]

The status indicates the controller cannot control flow to within the error band within a defined settling time. This diagnostic is **disabled** when **any** of the following conditions exists:

- [Ctrl_Setpoint] {3-1-6} = 0
- [Device_Status_Flow_Valid] {7-1-5} = 0

Bit Value	Description
1	$[\text{Flow}] \{2-1-6\} > ([\text{Ctrl_Setpoint}] \{3-1-6\} + (0.5 * [\text{Ctrl_Warn_Error_Band}] \{3-1-16\}))$ <p style="text-align: center;">OR</p> $[\text{Flow}] \{2-1-6\} < ([\text{Ctrl_Setpoint}] \{3-1-6\} - (0.5 * [\text{Ctrl_Warn_Error_Band}] \{3-1-16\}))$ <p style="text-align: center;">FOR</p> <p style="text-align: center;">Time Period > [Ctrl_Warn_Setting_Time] {3-1-15}</p>
0	$[\text{Flow} \{2-1-6\}] \leq ([\text{Ctrl_Setpoint}] \{3-1-6\} + (0.5 * [\text{Ctrl_Warn_Error_Band}] \{3-1-16\}))$ <p style="text-align: center;">AND</p> $[\text{Flow} \{2-1-6\}] \geq ([\text{Ctrl_Setpoint}] \{3-1-6\} - (0.5 * [\text{Ctrl_Warn_Error_Band}] \{3-1-16\}))$

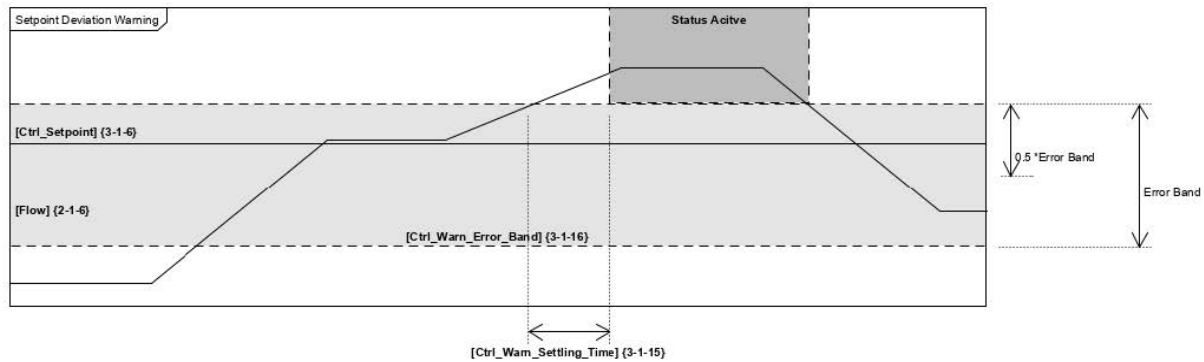

Section 7 Status

Bit 13: Setpoint Overrange [Active_Warnings_SP_Ovrng]

The status indicates the current setpoint has exceeded an upper threshold.

This diagnostic is *disabled* when [Ctrl_SP_Lim_Action] {3-1-201} = 0 (None)

Bit Value	Description
1	<p>[Ctrl_SP_Lim_Action] {3-1-201} = 1 (Raise Overrange Warning)</p> <p>AND</p> <p>[Ctrl_Setpoint] {3-1-6} > [Ctrl_SP_Lim] {3-1-194}</p> <p>FOR</p> <p>Time Period > 1 second</p>
0	<p>[Ctrl_SP_Lim_Action] {3-1-201} = 2 (Limit Setpoint) OR 0 (None)</p> <p>OR</p> <p>[Ctrl_Setpoint] {3-1-6} < [Ctrl_SP_Lim] {3-1-194}</p> <p>FOR</p> <p>Time Period > 1 second</p>

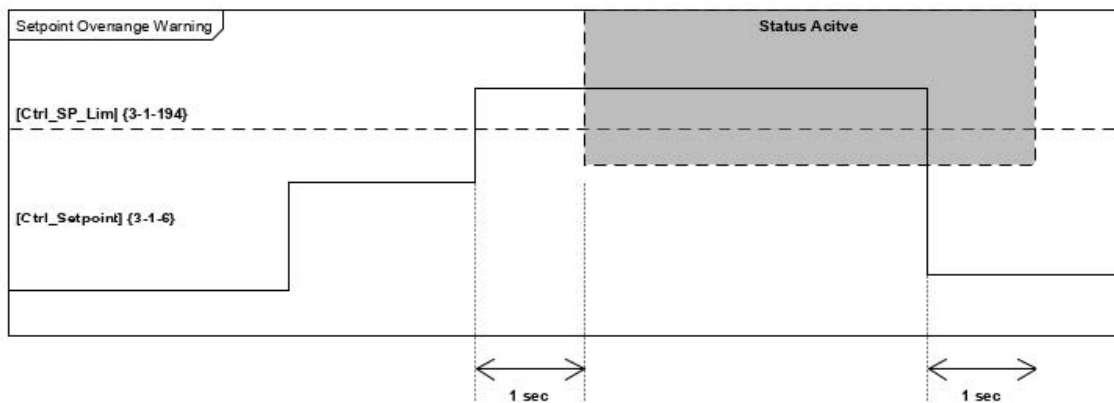

Section 7 Status

Bit 14: Setpoint Limited [Active_Warnings_SP_Limited]

The status indicates the [Ctrl_Setpoint] {3-1-6} has been limited by a [Ctrl_SP_Lim] {3-1-194}.

When [Ctrl_Setpoint] {3-1-6} < [Ctrl_SP_Lim] {3-1-194} then
 [Ctrl_Live_Setpoint] {3-1-202} = [Ctrl_Setpoint] {3-1-6}.

When [Ctrl_Setpoint] {3-1-6} >= [Ctrl_SP_Lim] {3-1-194} then
 [Ctrl_Live_Setpoint] {3-1-202} = [Ctrl_SP_Limit] {3-1-6}.

This diagnostic is *disabled* when [Ctrl_SP_Lim_Action] {3-1-201} = 0 (None)

Bit Value	Description
1	[Ctrl_SP_Lim_Action] {3-1-201} = 2 (Limit Setpoint) AND [Ctrl_Setpoint] {3-1-6} > [Ctrl_SP_Lim] {3-1-194} FOR Time Period > 1 second
0	[Ctrl_SP_Lim_Action] {3-1-201} = 2 (Limit Setpoint) OR 0 (None) OR [Ctrl_Setpoint] {3-1-6} < [Ctrl_SP_Lim] {3-1-194} FOR Time Period > 1 second

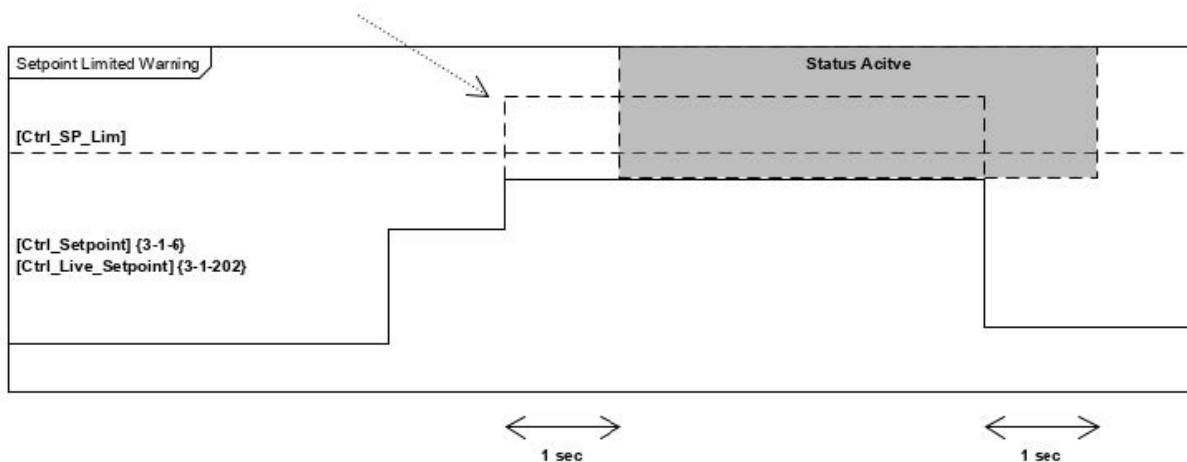

Section 7 Status

Bit 17: Calibration Due [Active_Warnings_Cal_Due]

This status indicates the devices needs to be calibrated.

See section Flow Meter Module, Section 6.x for details on Totalizers and Timers.

Bit Value	Description
1	[Cal_Due_Hours] {2-1-227} = 0
0	[Cal_Due_Hours] {2-1-227} > 0

Bit 18: Totalizer Overflow [Active_Warnings_Total_Ovflow]

This status indicates that [Flow_Totalizer] {2-1-126} has exceeded a defined overflow threshold.

See section Flow Meter Module, Section 6.x for details on Totalizers and Timers.

Bit Value	Description
1	[Flow_Totalizer] {2-1-126} > [Tot_Ovfl_Threshold] {2-1-230}
0	[Flow_Totalizer] {2-1-126} <= [Tot_Ovfl_Threshold] {2-1-230}

Bit 19: Overhaul Due [Active_Warnings_Overhaul_Due]

This status indicates that device requires maintenance.

See section Flow Meter Module, Section 6.x for details on Totalizers and Timers.

Bit Value	Description
1	[Overhaul_Due_Hours] {2-1-226} = 0
0	[Overhaul_Due_Hours] {2-1-226} > 0

Section 7 Status

Bit 24: High Temperature Warning [Active_Warnings_High_Temp]

The status indicates a high internal device temperature warning condition.

See Diagram in section Typical Status High/Low Processing for typical behavior of this status.

Bit Value	Description
1	[Temperature] {164-1-6} > [High_Temp_Warn_TP] {164-1-21} FOR Time Period > [Temp_Warn_Setting_Time] {164-1-24}
0	[Temperature] {164-1-6} < [High_Temp_Warn_TP] {164-1-21} FOR Time Period > [Temp_Warn_Setting_Time] {164-1-24}

Bit 25: Low Temperature Warning [Active_Warnings_Low_Temp]

This status indicates a low internal device temperature status condition.

See Diagram in section Typical Status High/Low Processing for typical behavior of this status.

Bit Value	Description
1	[Temperature] {164-1-6} < [Low_Temp_Warn_TP] {164-1-22} FOR Time Period > [Temp_Warn_Setting_Time] {164-1-24}
0	[Temperature] {164-1-6} > [Low_Temp_Warn_TP] {164-1-22} FOR Time Period > [Temp_Warn_Setting_Time]

Bit 26: Supply Volts High [Active_Warnings_High_Supply_Volts]

The status indicates the supply voltage is above the high warning trip point.

See Diagram in section Typical Status High/Low Processing for typical behavior of this status.

Bit Value	Description
1	[Supply_V] {100-1-191} < [Supply_V_Max_Limit] {100-1-192} FOR Time Period > [Supply_V_Settle_Time] {100-1-193}
0	[Supply_V] {100-1-191} > [Supply_V_Max_Limit] {100-1-192} FOR Time Period > [Supply_V_Settle_Time] {100-1-193}

Section 7 Status

Bit 27: Supply Volts Low [Active_Warnings_Low_Supply_Volts]

The status indicates the supply voltage is below the low warning trip point.

See Diagram in section Typical Status High/Low Processing for typical behavior of this status.

Bit Value	Description
1	<p style="text-align: center;">[Supply_V] {100-1-190} > [Supply_V_Min_Limit] {100-1-191}</p> <p style="text-align: center;">FOR</p> <p style="text-align: center;">Time Period > [Supply_V_Settle_Time] {100-1-193}</p>
0	<p style="text-align: center;">[Supply_V] {100-1-190} < [Supply_V_Min_Limit] {100-1-191}</p> <p style="text-align: center;">FOR</p> <p style="text-align: center;">Time Period > [Supply_V_Settle_Time] {100-1-193}</p>

Section 7 Status

Alarms {7-1-4}**Bit 0: Low Flow Alarm [Active_Alarms_Low_Flow]**

The status indicates a low flow alarm condition.

See Diagram in section Typical Status High/Low processing for typical behavior of this status.

This diagnostic is *disabled* when [Device_Status_Flow_Valid] {7-1-6} = 0

Bit Value	Description
1	$[\text{Flow}] \{2-1-6\} < [\text{Flow_Alarm_TP_Low}] \{2-1-18\}$ <p style="text-align: center;">FOR</p> $\text{Time Period} > [\text{Flow_Alarm_Settling_Time}] \{2-1-23\}$
0	$[\text{Flow}] \{2-1-6\} > ([\text{Flow_Alarm_TP_Low}] \{2-1-18\} + [\text{Flow_Alarm_Hyst}] \{2-1-19\})$ <p style="text-align: center;">FOR</p> $\text{Time Period} > [\text{Flow_Alarm_Settling_Time}] \{2-1-23\}$

Bit 1: High Flow Alarm [Active_Alarms_High_Flow]

This status indicates a high flow alarm condition.

See Diagram in section Typical Status High/Low Processing for typical behavior of this status.

This diagnostic is *disabled* when [Device_Status_Flow_Valid] {7-1-6} = 0.

Bit Value	Description
1	$[\text{Flow}] \{2-1-6\} > [\text{Flow_Alarm_TP_High}] \{2-1-17\}$ <p style="text-align: center;">FOR</p> $\text{Time Period} > [\text{Flow_Alarm_Settling_Time}] \{2-1-23\}$
0	$[\text{Flow}] \{2-1-6\} < ([\text{Flow_Alarm_TP_High}] \{2-1-17\} - [\text{Flow_Alarm_Hyst}] \{2-1-19\})$ <p style="text-align: center;">FOR</p> $\text{Time Period} > [\text{Flow_Alarm_Settling_Time}] \{2-1-23\}$

Section 7 Status

Bit 2: No Flow Alarm [Active_Alarms_No_Flow]

This status indicates a no flow conditions exists.

This diagnostic is *disabled* when *any* of the following conditions exist:

- [Device_Status_Flow_Valid] {7-1-6} = 0
- [Ctrl_Setpoint] {3-1-6} = 0
- [Valve_Override] {4-1-5} = 1 (Off)

Bit Value	Description
1	$[\text{Flow}] \{2-1-6\} < ([\text{No_Flow_Lim}] \{2-1-222\} * [\text{Ctrl_Setpoint}] \{3-1-6\})$ <p style="text-align: center;">AND</p> $[\text{Valve_Position}] \{4-1-6\} > [70\% * \text{Max Valve Position}]$ <p style="text-align: center;">FOR</p> <p style="text-align: center;">Time Period > [No_Flow_Setting_Time] {2-1-223}</p>
0	$[\text{Flow}] \{2-1-6\} > ([\text{No_Flow_Lim}] \{2-1-222\} * [\text{Ctrl_Setpoint}] \{3-1-6\})$ <p style="text-align: center;">OR</p> $[\text{Valve_Position}] \{4-1-6\} < [70\% * \text{Max Valve Position}]$ <p style="text-align: center;">FOR</p> <p style="text-align: center;">Time Period > [No_Flow_Setting_Time] {2-1-223}</p>

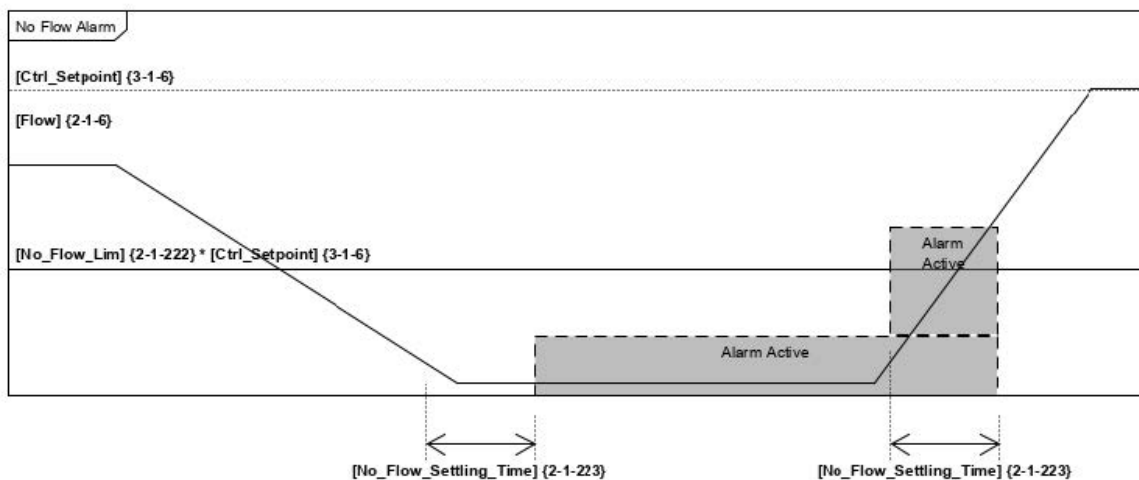

Section 7 Status

Bit 3: Choked Flow Alarm [Active_Alarms_Choked_Flow]

This status indicates a choked flow condition exists.

This diagnostic is *disabled* when *any* of the following conditions exist:

- [Device_Status_Flow_Valid] {7-1-6} = 0
- [Ctrl_Setpoint] {3-1-6} = 0
- [Valve_Override] {4-1-5} = 1 (Off)

Bit Value	Description
1	$[\text{Flow}] \{2-1-6\} < ([\text{Choked_Flow_Lim}] \{2-1-224\} * [\text{Ctrl_Setpoint}] \{3-1-6\})$ <p style="text-align: center;">AND</p> $[\text{Valve_Position}] \{4-1-6\} > [70\% * \text{Max Valve Position}]$ <p style="text-align: center;">FOR</p> <p style="text-align: center;">Time Period > [Choked_Flow_Setting_Time] {2-1-225}</p>
0	$[\text{Flow}] \{2-1-6\} > ([\text{Choked_Flow_Lim}] \{2-1-224\} * [\text{Ctrl_Setpoint}] \{3-1-6\})$ <p style="text-align: center;">OR</p> $[\text{Valve_Position}] \{4-1-6\} < [70\% * \text{Max Valve Position}]$ <p style="text-align: center;">FOR</p> <p style="text-align: center;">Time Period > [Choked_Flow_Setting_Time] {2-1-225}</p>

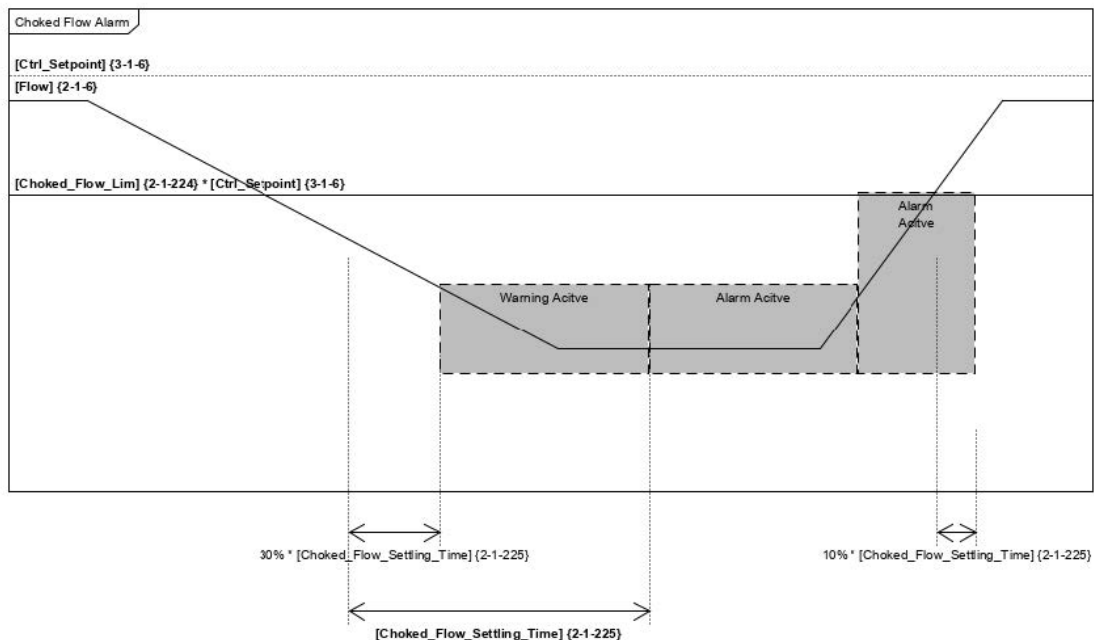

Section 7 Status

Bit 15: Invalid Process Gas Page Selected [Active_Alarms_Invalid_Cal_Page]

This status indicates that an invalid process gas page ID is being selected through output assembly 101 or assembly 102. This status will be set but the process gas page will not be changed.

Bit Value	Description
1	This bit is set when an invalid process gas page ID is received by the device
0	The process gas page received by the device is valid

Bit 23: Using Backup NV Memory [Active_Alarms_NV_Mem]

This status indicates that primary non-volatile memory has failed, and the device is using backup nonvolatile memory.

Bit Value	Description
1	This bit is set when NV Memory write failure has been detected
0	Indicates NV Memory write failure has not occurred

Bit 24: Temperature Sensor Fail [Active_Alarms_Temp_Sens_Fail]

This status indicates the operational status of the temperature sensor.

Bit Value	Description
1	Indicates the temperature sensor is non-functional
0	Indicates the temperature sensor is functional

Section 7 Status

Errors {7-1-3}**Bit 2: Back Streaming Error [Active_Errors_Bk_Stream]**

This status indicates that back stream condition exists.

This diagnostic is *disabled* when *any* of the following conditions exist:

- [Valve_Override] {4-1-5} = 2 (Purge)
- [Device_Status_Dev_Zeroing] {7-1-6} = 1
- [Devcie_Status_Dev_Alarms] {7-1-6} = 1
- [Device_Status_Dev_Exec] {7-1-6} = 0

Bit Value	Description
1	[Flow] < [Bk_Stream_Flow_Lim] FOR Time Period > [Bk_Stream_Time_Lim]
0	This bit can only be cleared with a reset of the device

Bit 18: Internal Communication Error [Active_Errors_Int_Comms]

This status indicates that a communications error between the Main Board and the Communications Adapter board has been detected.

This diagnostic is *disabled* when [Device_Status_Flow_Valid] {7-1-6} = 0.

Bit Value	Description
1	Error Detected
0	This bit can only be cleared with a reset of the device

Bit 23: NV Memory Fail [Active_Errors_NV_Mem_Fail]

This status indicates that both primary and backup non-volatile memories have had write failures detected.

Bit Value	Description
1	Non-volatile memory fail detected
0	This bit can only be cleared with a reset of the device

Section 7 Status

Typical Status High/Low Processing

The following diagrams represent typical Status Low and Status High processing of signals. Several status definitions reference these diagrams.

Status Low Processing

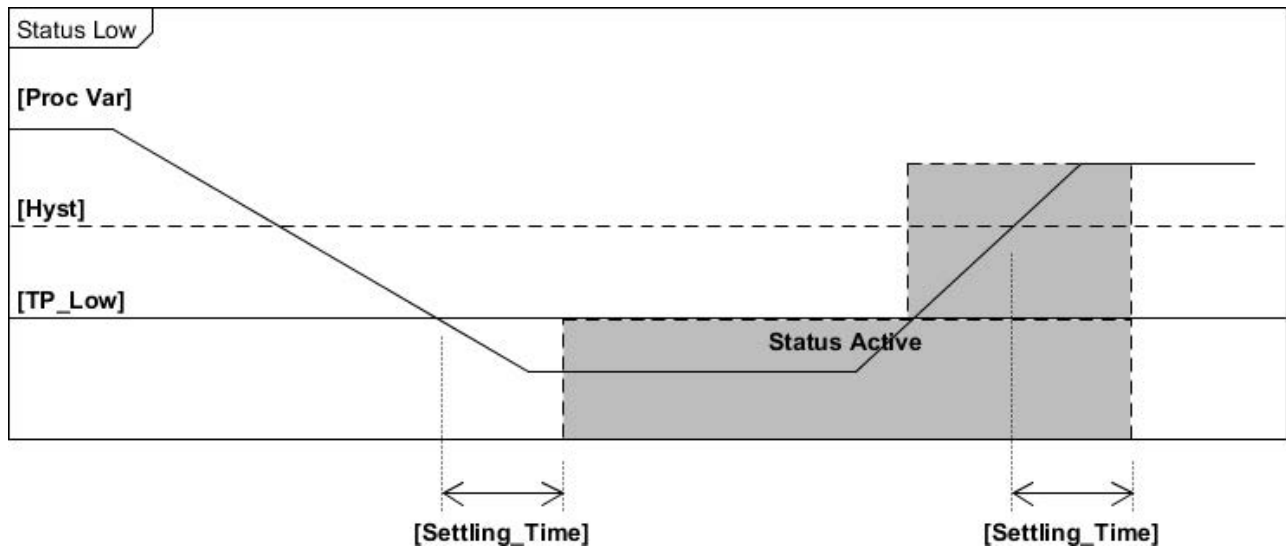

Status High Processing

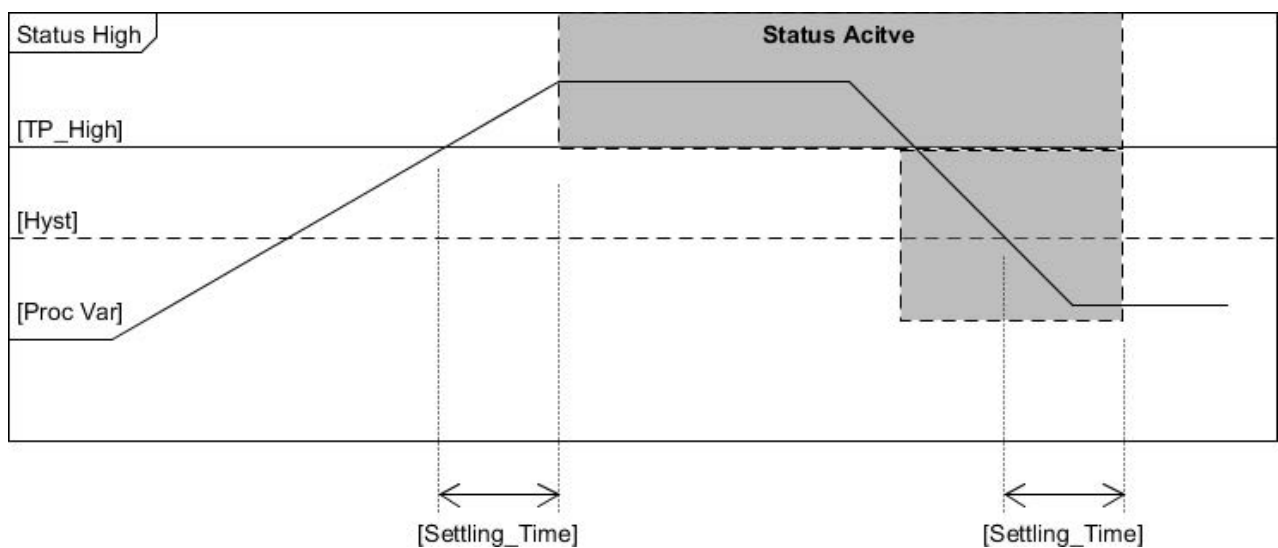

Section 8 Troubleshooting

Section 8: Troubleshooting

Problem	Possible Causes
Scanner is actively scanning the network, but the NET LED is flashing green and MOD LED is solid green.	The device Name configured in the scanner does not match the device Name set in the MFC/MFM.
Scanner is actively scanning the network and NET LED goes from solid green to flashing red and the MOD LED is solid green.	The cyclic data connection to the device has timed out and has not been re-established.
When power is applied to the device the NET LED remains off and the MOD LED is solid green.	The device Name has not been set.
When power is applied to the device, the MOD LED switches from flashing Red/Green to solid Red.	Cycle power to the device. If problem persists, contact Brooks Instrument Technical Services.
The device never comes out of Self-Test (MOD LED continually flashes red/green).	Cycle power to the device. If problem persists, contact Brooks Instrument Technical Services.

Section 9 Appendix

Section 9: Appendix

Appendix A

Intentionally left blank

Appendix B- Data Type Definitions

The following table list data types used throughout this manual and in the ODVA specification. The column C/C++ Encoding is given as a comparative common example reference.

Table 9-1 Data Types

Data Type	Size (bytes)	Description	Range	C/C++ Keyword
BOOL	1	A true/false represented as 0 = false and 1 = true	0 and 1	bool
SINT	1	An 8-bit signed integer value	-128 to 127	char
USINT	1	An 8-bit unsigned integer value	0 to 255	unsigned char
INT	2	A 16-bit signed integer value	-32768 to 32767	short int
UINT	2	A 16-bit unsigned integer value	0 to 65535	unsigned short int
DINT	4	A 32-bit signed integer value	-2147483648 to 2147483647	int
UDINT	4	A 32-bit unsigned integer	0 to 4294967296	unsigned int
REAL	4	An IEEE single precision floating point number	3.4E38 to -3.4E38	float
DREAL	8	An IEEE double precision floating point number		Long
ENGUNIT	1	An enumerated value representing an engineering unit of measure	4096 - 65535	N/A
BYTE	1	An 8-bit Bitfield	N/A	N/A
SHORT STRING	Up to 128 bytes	A character array where the first byte is the number of characters in the array, and the subsequent bytes contain the ASCII characters. This is not a NULL terminated string.	N/A	N/A

Section 9 Appendix

Appendix C – Data Units

Table 9-2: Volumetric Flow Units Table

Description	Symbol	Units Code	
		Decimal	Hex
Percent	%	4103	0x1007
Barrels per Day	bbl/day	2072	0x0818
Barrels per Hour	bbl/hr	2071	0x0817
Barrels per Minute	bbl/min	2070	0x0816
Barrels per Second	bbl/sec	2069	0x0815
Cubic Centimeters per Day	cc/day	2051	0x0803
Cubic Centimeters per Hour	cc/hr	2050	0x0802
Cubic Centimeters per Minute	cc/min	2049	0x0801
Cubic Centimeters per Second	cc/sec	2048	0x0800
Cubic Foot per Day	cu ft/day	2059	0x080B
Cubic Foot per Hour	cu ft/hr	2058	0x080A
Cubic Foot per Minute	cu ft/min	5122	0x1402
Cubic Foot per Second	cu ft/sec	2057	0x0809
Gallons per Day	gal/day	2064	0x0810
Gallons per Hour	gal/hr	5130	0x140A
Gallons per Minute	gal/min	5129	0x1409
Gallons per Second	gal/sec	5128	0x1408
Grams per Day	g/day	2075	0x081B
Grams per Hour	g/hr	2074	0x081A
Grams per Minute	g/min	5135	0x140F
Grams per Second	g/sec	2073	0x0819
Imperial Gallons per Day	imp gal/day	2068	0x0814
Imperial Gallons per Hour	imp gal/hr	2067	0x0813
Imperial Gallons per Minute	imp gal/min	2066	0x0812
Imperial Gallons per Second	imp gal/sec	2065	0x0811
Cubic Inch per Day	cu in/day	2063	0x080F
Cubic Inch per Hour	cu in/hr	2062	0x080E
Cubic Inch per Minute	cu in/min	2061	0x080D
Cubic Inch per Second	cu in/sec	2060	0x080C
Kilograms per Day	kg/day	2077	0x081D
Kilograms per Hour	kg/hr	5136	0x1410
Kilograms per Minute	kg/min	2076	0x081C
Kilograms per Second	kg/sec	5124	0x1404
Pounds per Day	lbs/day	2078	0x081E
Pounds per Hour	lbs/hr	5133	0x140D
Pounds per Minute	lbs/min	5132	0x140C
Pounds per Second	lbs/sec	5131	0x140B

Section 9 Appendix

Table 9-2: Volumetric Flow Units Table Continued

Description	Symbol	Units Code	
		Decimal	Hex
Liters per Day	L/day	2053	805
Liters per Hour	L/hr	5140	0x1414
Liters per Minute	L/min	5139	0x1413
Liters per Second	L/sec	5126	0x1406
Cubic Meters per Day	m3/day	2056	0x0808
Cubic Meters per Hour	m3/hr	2055	0x0807
Cubic Meters per Minute	m3/min	2054	0x0806
Cubic Meters per Second	m3/sec	5125	0x1405
Milliliters per Day	mL/day	2052	0x0804
Milliliters per Hour	mL/hr	5138	0x1412
Milliliters per Minute	mL/min	5137	0x1411
Milliliters per Second	mL/sec	5127	0x1407
Ounces per Day	oz/day	2082	0x0822
Ounces per Hour	oz/hr	2081	0x0821
Ounces per Minute	oz/min	2080	0x0820
Ounces per Second	oz/sec	2079	0x081F
Standard Cubic Centimeters per Second	sccm	5120	0x1400
Standard Liters per Minute	SLPM	5121	0x1401

Table 9-3: Actuator Units

Description	Symbol	Units Code	
		Decimal	Hex
Percent	%	4103	0x1007

Table 9-4: Temperature Units

Description	Symbol	Units Code	
		Decimal	Hex
deg C	°C	4608	0x1200
deg F	°F	4609	0x1201

Table 9-5: Volume Units Table Used by Totalizers

Description	Symbol	Units Code	
		Decimal	Hex
Liter	L	11778	0x2E02
Cubic Centimeter	cm3	11793	0x2E11

Section 10 Glossary

Section 10: Glossary

This section is intended as a brief overview of PROFINET™ terminology used throughout this manual.

Parameter

A Parameter or Data Item that may be read or written and is used for the purpose of configuration or is used to obtain information.

Example:

The parameter Data Units defines the engineering units flow will be reported in. The parameter Value indicates the current flow through the device. Parameters can be read/write or read only.

Module

A logical collection of related Parameters that define a particular function and/or behavior.

Example:

The module Flow Meter contains information about configuring a the flow sensor, the current status of the sensor, and/or the current value of what is being sensed.

Connection

A connection is a logical link between two devices by which messages are transferred. A device can have 1 or more simultaneous Connections.

GSDML

The General Station Description XML (GSDML) is a specially formatted text description for a device that describes the connection characteristics and configurable parameters that are accessible via the PROFINET™ network.

EPATH

An EPATH is a unique identifier comprised of a Module/Slot ID, a Subslot ID, and an Index ID.

Safe State (Safe Mode)

An operational mode or state that is considered “safe” whereby the normal controller process is shut down and mechanical and sensing mechanisms are placed in a safe condition.

LIMITED WARRANTY

Visit www.BrooksInstrument.com for the terms and conditions of our limited warranty.

BROOKS SERVICE AND SUPPORT

Brooks is committed to assuring all our customers receive the ideal flow solution for their application, along with outstanding service and support to back it up. We operate first class repair facilities located around the world to provide rapid response and support. Each location utilizes primary standard calibration equipment to ensure accuracy and reliability for repairs and recalibration and is certified by our local Weights and Measures Authorities and traceable to the relevant International Standards.

Visit www.BrooksInstrument.com to locate the service location nearest to you.

START-UP SERVICE AND IN-SITU CALIBRATION

Brooks Instrument can provide start-up service prior to operation when required.

For some process applications, where ISO-9001 Quality Certification is important, it is mandatory to verify and/or (re)calibrate the products periodically. In many cases this service can be provided under in-situ conditions, and the results will be traceable to the relevant international quality standards.

SEMINARS AND TRAINING

Brooks Instrument can provide seminars and dedicated training to engineers, end users and maintenance persons.

Please contact your nearest sales representative for more details.

Due to Brooks Instrument's commitment to continuous improvement of our products, all specifications are subject to change without notice.

TRADEMARKS

Brooks is a trademark of Brooks Instrument, LLC
All other trademarks are the property of their respective owners.



X-DPT-PROFINET-SLA-Series-RevB-MFC-eng/2023-1

Global Headquarters

Brooks Instrument
407 West Vine Street
Hatfield, PA
19440-0903 USA

Toll-Free (USA): 888-554-FLOW
T: 215-362-3500

BrooksAM@BrooksInstrument.com

A list of all Brooks Instrument locations and contact details can be found at www.BrooksInstrument.com

© Copyright 2023 Brooks Instrument, LLC All rights reserved. Printed in U.S.A.

BROOKS[®]
INSTRUMENT
Beyond Measure